

Canon

 imageFORMULA

ScanFront 300/300P

Operation Guide

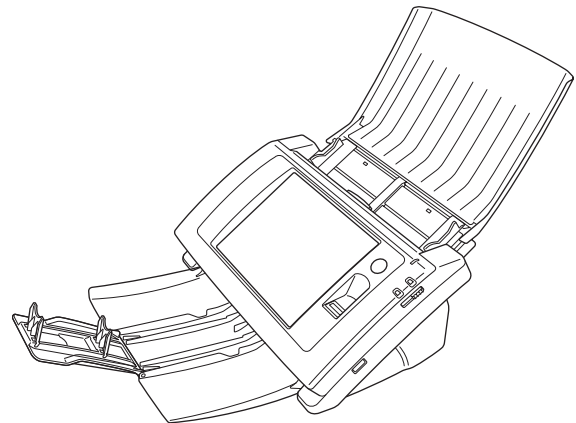

Please read this manual before using the scanner.
After you finish reading this manual, keep it in a safe place
for future reference.

International ENERGY STAR® Office Equipment Program

As an ENERGY STAR® Partner, Canon Electronics Inc. has determined that this machine meets the ENERGY STAR® Program guidelines for energy efficiency.



The International ENERGY STAR® Office Equipment Program is an international program that promotes energy saving through the use of computers and other office equipment.

The program backs the development and dissemination of products with functions that effectively reduce energy consumption. It is an open system in which business proprietors can participate voluntarily. The targeted products are office equipment, such as computers, monitors, printers, fax, machine, copiers, and scanners. The standards and logos are uniform among participating nations.

Under factory default settings, the scanner will enter Low Power mode after 12 minutes of inactivity. Although you can change the period of time before the scanner enters Low Power mode to up to 230 minutes, we recommend using the default setting.

FCC REGULATIONS (For 120 V model)

Network Scanner, Model M11-1041/M11-1051

This device complies with Part 15 of the FCC Rules.

Operation is subject to the following two conditions: (1) This device may not cause harmful interference, and (2) this device must accept any interference received, including interference that may cause undesired operation.

Note: This equipment has been tested and found to comply with the limits for a Class B digital device, pursuant to Part 15 of the FCC Rules. These limits are designed to provide reasonable protection against harmful interference in a residential installation. This equipment generates, uses, and can radiate radio frequency energy and, if not installed and used in accordance with the instructions, may cause harmful interference to radio communications. However, there is no guarantee that interference will not occur in a particular installation. If this equipment does cause harmful interference to radio or television reception, which can be determined by

turning the equipment off and on, the user is encouraged to try to correct the interference by one or more of the following measures:

- Reorient or relocate the receiving antenna.
- Increase the separation between the equipment and receiver.
- Connect the equipment into an outlet on a circuit different from that to which the receiver is connected.
- Consult the dealer or an experienced radio/TV technician for help.

Use of shielded cable is required to comply with class B limits in Subpart B of Part 15 of FCC Rules.

Do not make any changes or modifications to the equipment unless otherwise specified in the manual. If such changes or modifications should be made, you could be required to stop operation of the equipment.

Canon U.S.A. Inc.

One Canon Plaza, Lake Success NY 11042, U.S.A.

Tel. No. (516)328-5000

RADIO INTERFERENCE REGULATIONS (For 120 V models)

This digital apparatus does not exceed the Class B limits for radio noise emissions from digital apparatus as set out in the Interference-causing equipment standard entitled "Digital Apparatus", ICES-003 of the Industry Canada.

RÈGLEMENT SUR LE BROUILLAGE RADIOÉLECTRIQUE (For 120 V models)

Cet appareil numérique respecte les limites de bruits radioélectriques applicables aux appareils numériques de Classe B prescrites dans la norme sur le matériel brouilleur: "Appareils Numériques", NMB-003 édictée par l'Industrie Canada.

For CA, USA Only

Included battery contains Perchlorate Material - special handling may apply.

See <http://www.dtsc.ca.gov/hazardouswaste/perchlorate/> for detail.

European Union (and EEA) only



This symbol indicates that this product is not to be disposed of with your household waste, according to the WEEE Directive (2002/96/EC) and your national law. This product should be handed over to a designated collection point, e.g., on an authorized one-for-one basis when you buy a new similar product or to an authorized collection site for recycling waste electrical and electronic equipment (EEE). Improper handling of this type of waste could have a possible negative impact on the environment and human health due to potentially hazardous substances that are generally associated with EEE. At the same time, your cooperation in the correct disposal of this product will contribute to the effective usage of natural resources. For more information about where you can drop off your waste equipment for recycling, please contact your local city office, waste authority, approved WEEE scheme or your household waste disposal service. For more information regarding return and recycling of WEEE products, please visit www.canon-europe.com/environment. (EEA: Norway, Iceland and Liechtenstein)

Model Names

The following names may be provided for the safety regulations in each sales region of the Network Scanner.
ScanFront 300: Model M11-1041
ScanFront 300P: Model M11-1051

Trademarks

- Canon and the Canon logo are registered trademarks of Canon Inc. in the United States and may also be trademarks or registered trademarks in other countries.
- imageFORMULA is a trademark of Canon Electronics Inc.
- Microsoft, Windows, Internet Explorer, and Active Directory are registered trademarks or trademarks of Microsoft Corporation in the United States and other countries.
- Adobe, Acrobat, and Adobe Reader are registered trademarks or trademarks of Adobe Systems Incorporated in the United States and other countries.

- Other product and company names herein may be the trademarks of their respective owners.

Disclaimers

The information in this document is subject to change without notice.

CANON ELECTRONICS INC. MAKES NO WARRANTY OF ANY KIND WITH REGARD TO THIS MATERIAL, EITHER EXPRESS OR IMPLIED, EXPECT AS PROVIDED HEREIN, INCLUDING WITHOUT LIMITATION, THEREOF, WARRANTIES AS TO MARKETABILITY, MERCHANTABILITY, FITNESS FOR A PARTICULAR PURPOSE OF USE OR NON-INFRINGEMENT. CANON ELECTRONICS INC. SHALL NOT BE LIABLE FOR ANY DIRECT, INCIDENTAL, OR CONSEQUENTIAL DAMAGES OF ANY NATURE, OR LOSSES OR EXPENSES RESULTING FROM THE USE OF THIS MATERIAL.

CANON ELECTRONICS INC. IS NOT LIABLE FOR THE STORAGE AND HANDLING OF DOCUMENTS SCANNED WITH THIS PRODUCT, OR THE STORAGE AND HANDLING OF RESULTING SCANNED IMAGE DATA.

IF YOU INTEND TO DISCARD THE ORIGINALS OF SCANNED DOCUMENTS, YOU THE CUSTOMER ARE RESPONSIBLE FOR INSPECTING THE SCANNED IMAGES AND VERIFYING THAT DATA IS INTACT. THE MAXIMUM LIABILITY OF CANON ELECTRONICS INC. UNDER THIS WARRANTY IS LIMITED TO THE PURCHASE PRICE OF THE PRODUCT COVERED BY THE WARRANTY.

Copyright

libtiff

Copyright (c) 1988-1996 Sam Leffler

Copyright (c) 1991-1996 Silicon Graphics, Inc.

Permission to use, copy, modify, distribute, and sell this software and its documentation for any purpose is hereby granted without fee, provided that (i) the above copyright notices and this permission notice appear in all copies of the software and related documentation, and (ii) the names of

Sam Leffler and Silicon Graphics may not be used in any advertising or publicity relating to the software without the specific, prior written permission of Sam Leffler and Silicon Graphics.

THE SOFTWARE IS PROVIDED "AS-IS" AND WITHOUT WARRANTY OF ANY KIND, EXPRESS, IMPLIED OR OTHERWISE, INCLUDING WITHOUT LIMITATION, ANY WARRANTY OF MERCHANTABILITY OR FITNESS FOR A PARTICULAR PURPOSE.

IN NO EVENT SHALL SAM LEFFLER OR SILICON GRAPHICS BE LIABLE FOR ANY SPECIAL, INCIDENTAL, INDIRECT OR CONSEQUENTIAL DAMAGES OF ANY KIND, OR ANY DAMAGES WHATSOEVER RESULTING FROM LOSS OF USE, DATA OR PROFITS, WHETHER OR NOT ADVISED OF THE POSSIBILITY OF DAMAGE, AND ON ANY THEORY OF LIABILITY, ARISING OUT OF OR IN CONNECTION WITH THE USE OR PERFORMANCE OF THIS SOFTWARE.

libjpeg

Portions of this software are based in part on the work of the Independent JPEG Group.

MD5

derived from the RSA Data Security, Inc. MD5 Message-Digest Algorithm

Copyright (c) 1998 - 2002, Paul Johnston & Contributors
All rights reserved.

Redistribution and use in source and binary forms, with or without modification, are permitted provided that the following conditions are met:

Redistributions of source code must retain the above copyright notice, this list of conditions and the following disclaimer. Redistributions in binary form must reproduce the above copyright notice, this list of conditions and the following disclaimer in the documentation and/or other materials provided with the distribution.

Neither the name of the author nor the names of its contributors may be used to endorse or promote products derived from this software without specific prior written permission.

THIS SOFTWARE IS PROVIDED BY THE COPYRIGHT HOLDERS AND CONTRIBUTORS "AS IS" AND ANY EXPRESS OR IMPLIED WARRANTIES, INCLUDING, BUT NOT LIMITED TO, THE IMPLIED WARRANTIES OF MERCHANTABILITY AND FITNESS FOR A PARTICULAR PURPOSE ARE DISCLAIMED. IN NO EVENT SHALL THE COPYRIGHT OWNER OR CONTRIBUTORS BE LIABLE FOR ANY DIRECT, INDIRECT, INCIDENTAL, SPECIAL, EXEMPLARY, OR CONSEQUENTIAL DAMAGES (INCLUDING, BUT NOT LIMITED TO, PROCUREMENT OF SUBSTITUTE GOODS OR SERVICES; LOSS OF USE, DATA, OR PROFITS; OR BUSINESS INTERRUPTION) HOWEVER CAUSED AND ON ANY THEORY OF LIABILITY, WHETHER IN CONTRACT, STRICT LIABILITY, OR TORT (INCLUDING NEGLIGENCE OR OTHERWISE) ARISING IN ANY WAY OUT OF THE USE OF THIS SOFTWARE, EVEN IF ADVISED OF THE POSSIBILITY OF SUCH DAMAGE.

 LAMP(S) INSIDE THIS PRODUCT CONTAIN MERCURY AND MUST BE RECYCLED OR DISPOSED OF ACCORDING TO LOCAL, STATE OR FEDERAL LAWS.

Copyright 2010 by CANON ELECTRONICS INC. All rights reserved.

No part of this publication may be reproduced or transmitted in any form or by any means, electronic or mechanical, including photocopying and recording, or by any information storage or retrieval system without the prior written permission of CANON ELECTRONICS INC.

Introduction

Thank you for purchasing the Canon imageFORMULA ScanFront 300/300P network scanner.

Please read this manual thoroughly before using the scanner to familiarize yourself with its capabilities, and to make the most of its many functions. After reading this manual, store it in a safe place for future reference.

About ScanFront 300/300P

The ScanFront 300/300P is a network scanner that you can use without connecting to a computer.

You can transfer the data of an image scanned with the ScanFront 300/300P to a shared folder on a server PC or client PC on the network or to an FTP server*, send it to a printer for printing**, or deliver it to a remote location via e-mail or Internet fax service. When using the scanner without a network environment, you can also save the image files to USB memory.

* To send image files to a shared folder on a computer on a different segment of the network, the supplied ScanFront Service software must be installed on a computer on the network.

** To send image files to a printer, the supplied ScanFront Service software must be installed on a computer on the network.

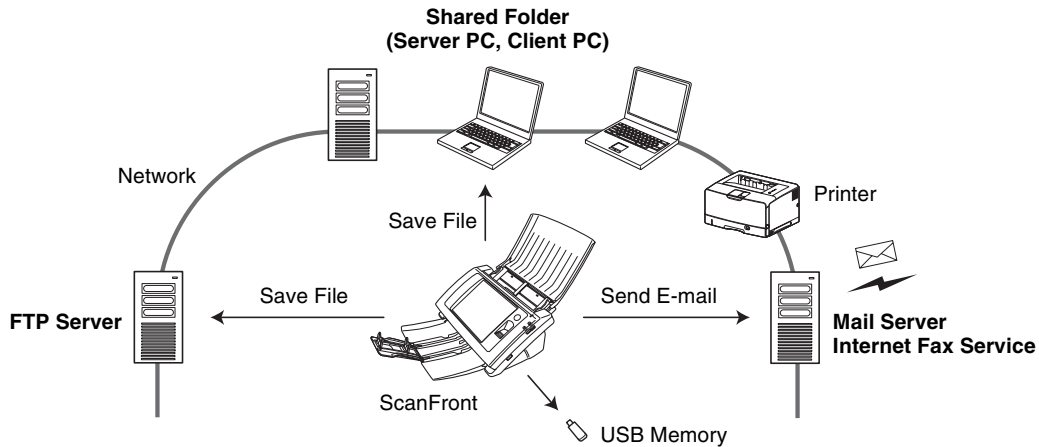

Conceptual Diagram of the ScanFront

❑ Manuals for the Scanner

The following manuals are provided with the Canon ScanFront 300/300P. Be sure to read these manuals thoroughly before using the scanner.

Setup Guide

Describes the procedure for setting up the scanner for scanning. Set up the ScanFront in accordance with the Setup Guide. For details on the ScanFront, refer to the *Operation Guide* and *ScanFront 300/300P INSTRUCTIONS* (electronic manuals).

Operation Guide (This Manual)*

Provides an overview of the functions of the scanner, and describes the basic operations for using the ScanFront. For details on the settings of the ScanFront, refer to the *ScanFront 300/300P INSTRUCTIONS* (electronic manual).

* The printed version of Operation Guide may vary depending on your region. PDF files of the Operation Guide in other languages can be found on the INSTRUCTIONS AND UTILITIES CD-ROM.

INSTRUCTIONS (Electronic Manual)

Describes how to use the scanner, and includes instructions for configuring the scanner settings, as well as handling, maintenance, and troubleshooting information. This manual is stored as a PDF file on the supplied INSTRUCTIONS AND UTILITIES CD-ROM and requires Adobe Reader to open. (You can download Adobe Reader from the Adobe Web site.)

❑ Symbols Used in This Manual

The following symbols are used in this manual to explain procedures, restrictions, handling precautions, and instructions that should be observed for safety.

WARNING

Indicates a warning concerning operations that may lead to death or injury to persons if not performed correctly. To use the scanner safely, always pay attention to these warnings.

CAUTION

Indicates a caution concerning operations that may lead to injury to persons, or damage to property if not performed correctly. To use the scanner safely, always pay attention to these cautions.

IMPORTANT

Indicates operational requirements and restrictions. Be sure to read these items carefully to operate the scanner correctly, and avoid damage to the scanner.

Hint

Indicates a clarification of an operation, or contains additional explanations for a procedure. Reading these notes is highly recommended.

□ **How This Manual is Organized**

This manual consists of the following chapters.

Chapter 1 Before Use

This chapter provides an overview of the ScanFront.

Chapter 2 Handling

This chapter describes the types of documents that can be scanned, and the basic operations of the scanner.

Chapter 3 Operating Procedures

This chapter describes the basic operating procedures for the scanner.

Chapter 4 Web Menu (User Mode)

This chapter describes the Web menu for the user to configure settings.

Chapter 5 Troubleshooting

This chapter describes how to respond when problems occur or warning messages appear.

Chapter 6 Index

□ Table of Contents

Introduction	i
Manuals for the Scanner	ii
Symbols Used in This Manual	ii
How This Manual is Organized	iii

Chapter 1 Before Use

1. Important Safety Instructions	1-2
Installation Location	1-2
Power	1-2
Moving the Scanner	1-3
Handling	1-3
About the Fingerprint Sensor (ScanFront 300P only)	1-5
Disposal	1-5
2. Names and Functions of Parts	1-6
Front and Document Feed and Eject Trays	1-6
Side and Rear	1-7

Chapter 2 Handling

1. Documents	2-2
Plain Paper	2-2
Business Card	2-2
Card	2-3
2. Preparing the Scanner	2-4
Preparing the Document Feed Tray and Eject Tray	2-4
Feed Selection Lever	2-5
USB Port	2-5
3. Placing Documents	2-6
Placing a Document	2-6
Placing a Folded Document	2-7
Placing a Long Document	2-7
Placing a Card	2-8
4. Clearing a Paper Jam or Double Feed Error	2-9
5. Fingerprint Sensor (ScanFront 300P)	2-11
Cautions for Handling the Fingerprint Sensor	2-11
Fingerprint Authentication	2-12

Chapter 3 Operating Procedures

1. Flow of Scanner Operations	3-2
2. Turning the Power ON and OFF	3-3
Turning the Power ON	3-3
Turning the Power OFF	3-3
3. Login Screen	3-4
Login Screen Types	3-4
When Using Server Authentication	3-4
List Type Login	3-5
Key in Type Login	3-6
Fingerprint Authentication (Only Available with the ScanFront 300P)	3-7
4. Screen Displayed after Login	3-8
Home Screen	3-8
Job Button Screen	3-8
5. User Settings Screen	3-9
Change Password	3-9
Fingerprint Registration	3-9
6. Fingerprint Registration (Only Available with the ScanFront 300P)	3-10
Fingerprint Authentication	3-10
Registering a Fingerprint	3-11
7. Scanning Procedures	3-13
Scanning From the Home Screen	3-13
Scanning From the Job Button Screen	3-14
Address Selection Screen	3-15
USB Memory Screen	3-16
Print Settings Screen	3-17
Scanning	3-18
8. Registering and Editing Addresses	3-22
Registering a New Address	3-22
Modifying an Address	3-25
Copying an Address	3-25
9. Scan/Delivery Options	3-27
Scan Settings	3-28
File Formats	3-32
Security Settings for PDF Files	3-33
Delivery Options	3-34

Chapter 4 Web Menu (User Mode)

- 1. Web Menu Overview4-2
- 2. Logging In to the Web Menu4-3
- 3. User Settings4-4
 - User Settings 4-5
- 4. Address Book Settings4-8
 - Registering New Addresses 4-10
 - Copying Addresses 4-13
 - Exporting and Importing Address Books 4-13
- 5. Job Button Settings4-15
 - Registering New Job Buttons 4-17
 - Scan Settings Overview 4-18
 - Copying Job Buttons 4-22
 - Editing Jobs 4-23
 - Exporting and Importing Job Buttons 4-23

Chapter 5 Troubleshooting

- 1. Troubleshooting5-2

Chapter 6 Index

- 1. Index6-2

Chapter 1 Before Use

1. Important Safety Instructions	1-2
Installation Location	1-2
Power	1-2
Moving the Scanner	1-3
Handling	1-3
About the Fingerprint Sensor (ScanFront 300P only)	1-5
Disposal	1-5
2. Names and Functions of Parts.....	1-6
Front and Document Feed and Eject Trays	1-6
Side and Rear	1-7

1. Important Safety Instructions

To ensure the safe operation of this scanner, be sure to read the safety warnings and precautions described below.

□ Installation Location

The performance of this scanner is affected by the environment in which it is installed. Make sure that the location where the scanner is installed meets the following environmental requirements.

- Provide adequate space around the scanner for operation, maintenance, and ventilation.

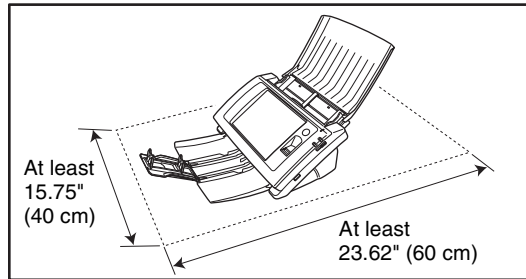

- Avoid installing the machine in direct sunlight. If this is unavoidable, use curtains to shade the scanner.
- Avoid locations where a considerable amount of dust accumulates.
- Avoid warm or humid locations, such as in the vicinity of a water faucet, water heater, or humidifier, and avoid locations where the fumes from ammonia, paint thinner, or other volatile chemicals may be present.
- Avoid locations that are subject to vibration.

- Avoid exposing the scanner to rapid changes in temperature. If the room in which the scanner is installed is cold but rapidly heated, water droplets (condensation) may form inside the scanner. This may result in a noticeable degradation in scanning quality.

The following conditions are recommended for optimal scanning quality:

Room temperature: 10 °C to 32.5 °C (50 °F to 90.5 °F)

Humidity: 20% to 80% RH

- Avoid installing the scanner near equipment that generates a magnetic field (e.g. speakers, televisions, or radios).

□ Power

- Connect only to a power outlet of the rated voltage and power supply frequency (either 120 V, 60 Hz or 220-240 V, 50/60 Hz, depending on your region).
- Do not connect other electrical equipment to the same power outlet to which the scanner is connected. Also, when using an extension cord, make sure that the extension cord is rated for the current requirements of the scanner.
- Never try to disassemble the AC adapter or modify it in any way, as this is extremely dangerous.
- The power cord and AC adapter may become damaged if they are often stepped on or if heavy objects are placed on them. Continued use of a damaged power cord and AC adapter can lead to an accident, such as a fire or electrical shock.
- Do not use the power cord while it is coiled.

- Do not pull directly on the power cord. When disconnecting the power cord, grasp the plug and remove it from the outlet.
- Keep the area around the power plug clear of objects so that the power cord can be disconnected easily in an emergency.
- Use only the AC adapter provided with this scanner. Also, do not use the AC adapter provided with the scanner with any other electrical devices.
Model: MG1-4314
- If you have any questions regarding the power supply, contact your local authorized Canon dealer or service representative for further information.

□ Moving the Scanner

- When moving the scanner, always hold it with both hands to avoid dropping it. The weight of the scanner unit is approximately 7.9 lbs (3.6 kg).
- Before moving the scanner, make sure the document tray is closed and the interface cable and AC adapter are disconnected. If the scanner is transported with these items connected, the plugs and connectors may be damaged due to excessive force applied to them during movement.

□ Handling

WARNING

Note the following precautions whenever using the scanner. Failure to do so may result in a fire or electric shock.

- Never use alcohol, benzene, paint thinner, aerosol sprays, or any other highly flammable substance near the scanner.

- Do not cut, damage, or modify the power cord or AC adapter. Do not place heavy objects on the power cord or AC adapter, and do not pull or excessively bend the power cord.
- Never connect the power cord when your hands are wet.
- Do not connect the scanner to a multiplug power strip.
- Do not knot or coil the power cord, as this may result in a fire or electric shock. When connecting the power cord, make sure that the power plug is securely and completely inserted into the power outlet.
- Do not use power cords and AC adapters other than the power cord and AC adapter provided with this scanner.
- Never try to take the scanner apart or modify it in any way.
- Never try to take the AC adapter apart or modify it in any way, as this is dangerous and may lead to a fire or electric shock.
- Do not use flammable aerosol sprays near the scanner.
- When cleaning the scanner, turn the power OFF and disconnect the power cord from the power supply.
- Clean the scanner using a slightly dampened cloth which has been well wrung out. Never use alcohol, benzene, paint thinner, or any other flammable substances.

- If the scanner makes strange noises, or gives off, smoke, heat, or strange odors, or the scanner does not function or other abnormalities occur when you use the machine, immediately turn the power OFF, and disconnect the power plug from the power outlet. Then, contact your local authorized Canon dealer or service representative for further information.
- Do not drop the scanner, or subject it to impact or strong shock. Should the scanner ever become damaged, immediately turn the power OFF, and disconnect the power plug from the power outlet. Then, contact your local authorized Canon dealer or service representative to have the unit serviced.
- Before moving the scanner, make sure to turn the power OFF, and disconnect the power plug from the power outlet.

CAUTION

- Do not install the scanner on a surface that is unstable or tilted, or in an area subject to excessive vibrations, as this may cause the scanner to fall, resulting in personal injury or damage to the scanner.
 - Do not block the ventilation openings. Doing so could cause the scanner to overheat, creating a risk of fire.
 - Never place small metal objects such as staples, paper clips, or jewelry on the scanner. These items may fall into the scanner, and cause a fire or electric shock. Should such objects ever fall inside the scanner, immediately turn the power OFF, and disconnect the power plug from the power outlet. Then, contact your local authorized Canon dealer or service representative to have the unit serviced.
- Do not install the scanner in a humid or dusty location. Doing so may result in a fire or electric shock.
 - Do not place objects on top of the scanner, as they may tip over and fall, resulting in personal injury.
 - Do not use the scanner with a power supply voltage other than 120/220-240 VAC. Doing so might cause fire or electric shock.
 - When disconnecting the power cord, grasp it firmly by its plug. Do not pull directly on the power cord, as this may damage or expose the cord's internal wiring, resulting in a fire or electric shock.
 - Leave sufficient space around the power plug so that it can be disconnected easily. If objects are placed around the power plug, you will be unable to disconnect it in an emergency.
 - Do not allow water or flammable substances (alcohol, paint thinner, benzene, etc.) to spill into the scanner, as this may result in a fire or electric shock.
 - Turn OFF the power for safety when not using the scanner for a long period of time, such as overnight. Also, turn OFF the power, and disconnect the AC adapter from the scanner and disconnect the power cord from the power outlet for safety when the machine will not be used for an extended period of time, such as during consecutive holidays.
 - Do not wear loose clothing or jewelry that may get caught in the scanner while you are using it. This may result in personal injury. Be extra careful of neckties and long hair. If anything becomes caught in the scanner, immediately disconnect the power cord to stop the scanner.
 - Be careful when placing paper in the scanner and when removing jammed paper. It is possible to cut your hand on the edge of a sheet of paper.

❑ About the Fingerprint Sensor (ScanFront 300P only)

- The following actions may damage the sensor or cause it to malfunction:
 - Dropping an object on the fingerprint sensor, or otherwise subjecting it to a strong impact
 - Scratching the surface of the fingerprint sensor, or poking it with a pointed object
 - Pressing a hard object such as a fingernail or metal item against the fingerprint sensor
 - Touching the fingerprint sensor with dirty hands
 - Placing a sticker on the surface of the fingerprint sensor, or covering the surface with ink or another substance
- If fingerprint authentication fails frequently, the fingerprint sensor may be dirty. Clean the surface of the fingerprint sensor regularly.
- When cleaning the fingerprint sensor, use a soft dry cloth to wipe dirt off the surface.
- Do not use a pointed object to remove any dirt that accumulates around the fingerprint sensor. Doing so may cause the fingerprint sensor to malfunction.
- Touching the fingerprint sensor while charged with static electricity may cause the fingerprint sensor or scanner unit to malfunction. Before touching the fingerprint sensor, discharge any static electricity by touching a piece of metal. Be especially careful during dry periods, such as the winter season, when the likelihood of being charged with static electricity is high.

- When disposing of the scanner, make sure to follow all local ordinances and laws or consult with the retailer who sold you the scanner.

❑ Disposal

- Prior to disposing of the scanner, initialize the scanner to ensure that the registered data is deleted.

2. Names and Functions of Parts

The names and functions of the parts of the ScanFront 300/300P are shown below.

□ Front and Document Feed and Eject Trays

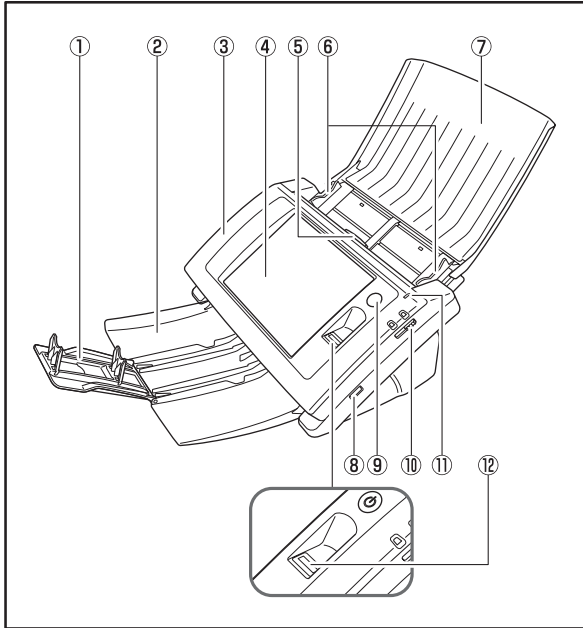

- ① **Tray Extension**
Open this to prevent scanned documents from slipping off.
- ② **Document Eject Tray**
Open this tray when using the ScanFront. If scanned documents curl in the document eject tray, remove the entire tray. (See p. 2-4.)
- ③ **Panel Unit**
Open this when there is a paper jam or to perform maintenance. (See p. 2-10.)
- ④ **Touch Panel**
Touch this screen to operate the ScanFront.
- ⑤ **Lock Lever**
Locks the panel unit. Pull the lever toward you to unlock the panel unit. (See p. 2-10.)
- ⑥ **Document Guides**
Adjust these to match the width of the document. (See p. 2-6.)
- ⑦ **Document Feed Tray**
Place documents here. (See p. 2-4.)
- ⑧ **USB Port (Front)**
Connect a USB1.1/Hi-Speed USB2.0 compatible USB memory device, USB keyboard, or USB mouse.
- ⑨ **Power Switch**
Use this to turn the power ON. (See p. 3-3.)
* Use the Power OFF button on the touch panel to turn the power OFF.
- ⑩ **Feed Selection Lever**
Use this lever to change the feed method for documents. (See p. 2-5.)
- ⑪ **Power Indicator**
Lights when the power is ON. (See p. 3-3.)
- ⑫ **Fingerprint Authentication Sensor (Only Available with the ScanFront 300P)**
This fingerprint sensor is for fingerprint registration and authentication. (See p. 2-11.)

❑ **Side and Rear**

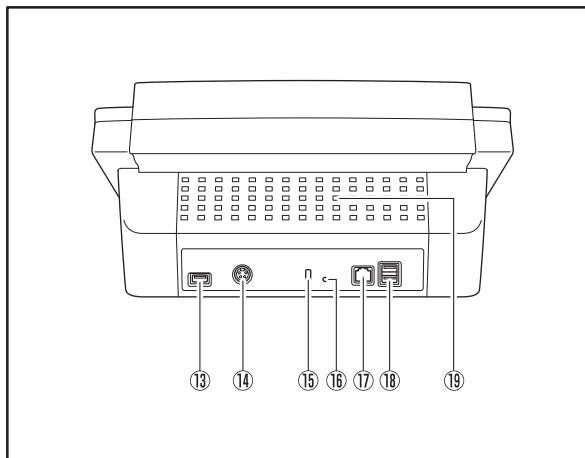

- ⑬ **USB Port (Rear Left)**
Connect a USB1.1/Hi-Speed USB2.0 compatible USB memory device, USB keyboard, or USB mouse.
- ⑭ **Power Connector (24 VDC)**
Connect the plug of the supplied AC adapter.
- ⑮ **Kensington Slot**
This is an anti-theft slot that enables a key chain or lock to be connected to prevent theft.
- ⑯ **Service Switch**
This is a service switch. Do not insert any object into this hole.
- ⑰ **LAN Port (RJ-45)**
Connect an RJ-45 (10Base-T/100Base-TX) compatible network cable.
- ⑱ **USB Ports (Rear Right)**
Connect a USB1.1/Hi-Speed USB2.0 compatible USB memory device, USB keyboard, or USB mouse.
- ⑲ **Ventilation Holes**

Chapter 2 Handling

1. Documents.....	2-2
Plain Paper.....	2-2
Business Card.....	2-2
Card	2-3
2. Preparing the Scanner.....	2-4
Preparing the Document Feed Tray and Eject Tray	2-4
Feed Selection Lever	2-5
USB Port	2-5
3. Placing Documents.....	2-6
Placing a Document.....	2-6
Placing a Folded Document.....	2-7
Placing a Long Document.....	2-7
Placing a Card.....	2-8
4. Clearing a Paper Jam or Double Feed Error ...	2-9
5. Fingerprint Sensor (ScanFront 300P).....	2-11
Cautions for Handling the Fingerprint Sensor	2-11
Fingerprint Authentication	2-12

1. Documents

The ScanFront can scan documents in a range of sizes from business cards to Legal/A4.

It is possible to feed documents of the following sizes and thicknesses depending on the feeding method used.

□ Plain Paper

Size

Width: 2" to 8 1/2" (50.8 mm to 216 mm)

Length: 2 1/8" to 14" (53.9 mm to 355.6 mm)

(up to 39.3" (1,000 mm) in Long Document mode)

Thickness for Page Separation ON

14 lb to 57 lb bond (52 g/m² to 209 g/m²)

Thickness for Page Separation OFF

11 lb to 57 lb bond (40 g/m² to 209 g/m²)

! IMPORTANT

A document must meet the following criteria to be scannable:

- When scanning a multipage document, pages must be grouped together so that they have the same size, thickness, and weight. Scanning different types of paper at one time can cause the scanner to jam.
- Always make sure that the ink on a document is dry before scanning it. Scanning documents with the ink still wet may soil the rollers or scanning glass, cause lines or smudges to appear on images, or dirty other documents.
- Always clean the rollers or scanning glass after scanning a document written in pencil. Scanning documents with pencil written on them may soil the rollers or scanning glass, cause stripes to appear in images, or dirty other documents.
- When scanning a two-sided document that is printed on thin paper, the image on the opposite side of each page may show through. Adjust the brightness in the scanning conditions before scanning the document.

- Note that scanning the following types of documents can cause a paper jam or malfunction. To scan such a document, make a photocopy of the document and then scan the photocopy.



Wrinkled or creased documents



Carbon paper



Curled documents



Coated paper



Torn documents



Extremely thin, translucent paper



Documents with paper clips or staples



Document with square punch holes

□ Business Card

Size

Width: 2" (50.8 mm) and above

Length: 2 1/8" (53.9 mm) and above

Thickness

82 lb Cover (300 g/m²) and below

! IMPORTANT

- If the stack of business cards that you placed is not fed properly, reduce the number business cards.
- Business cards may sometimes be stacked in the wrong order when they are ejected, depending on the size and thickness of the business cards, and the orientation that they are loaded.

❑ Card

Size

2.12" × 3.37" (53.9 × 85.5 mm) (Conforming to ISO Standards)

Thickness

0.0299" (0.76 mm) and below

Insertion orientation

Landscape

❗ IMPORTANT

- Insert cards one at a time.
- Be careful when inserting cards to avoid damaging them.

2. Preparing the Scanner

When placing a document in the scanner, pull out the document eject tray so that it matches the size of the document, and then move the feed selection lever to the appropriate position for the desired feed method (Page Separation ON or OFF) for the document.

□ Preparing the Document Feed Tray and Eject Tray

Prepare the trays in accordance with the type of document.

1. Open the document feed tray ①.
2. Open the document eject tray ②.

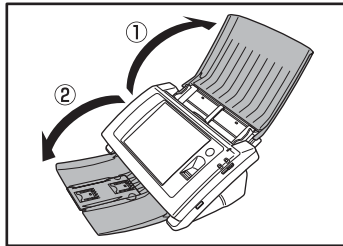

💡 Hint

Open the center tray extension when output documents are likely to fall out of the tray.

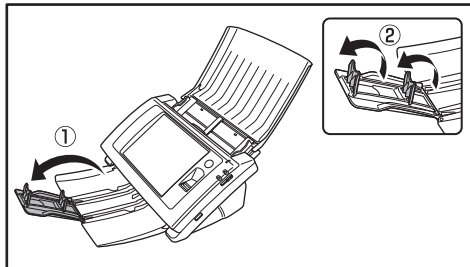

💡 Hint

If the output documents curl in the eject tray when scanning particularly thin documents, remove the eject tray.

To remove the document eject tray, push in on the illustrated portions of the tray on both sides in the direction of the arrows ① and pull out ②.

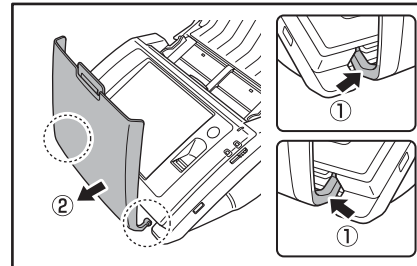

To reattach the eject tray, insert the protrusions on both sides of the tray into the holes on the scanner.

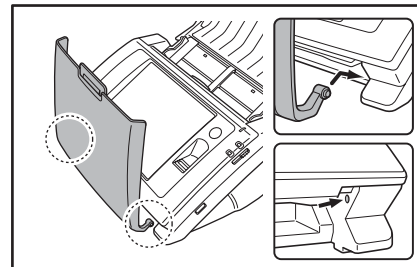

After connecting the tray, make sure that it is attached securely.

❑ Feed Selection Lever

Change the position of the lever to the desired feed method for the document.

Page Separation ON

Move the lever downward to separate a stack of documents one page at a time in order to continuously feed the documents.

Page Separation OFF

Move the lever upward to feed a document with multiple pages attached together such as an invoice one page at a time without separating the pages.

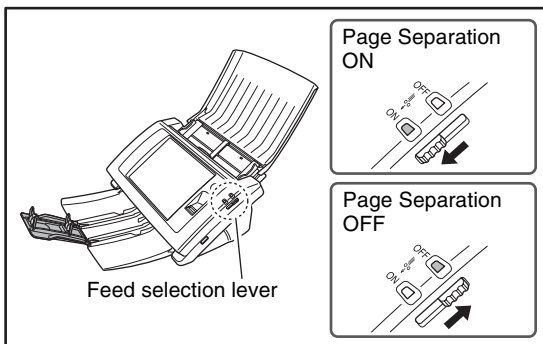

❗ IMPORTANT

Moving the lever upward (Page Separation OFF) and then scanning a stack of documents will cause multiple pages to be fed at the same time.

❑ USB Port

You can insert a USB memory device to store image files.

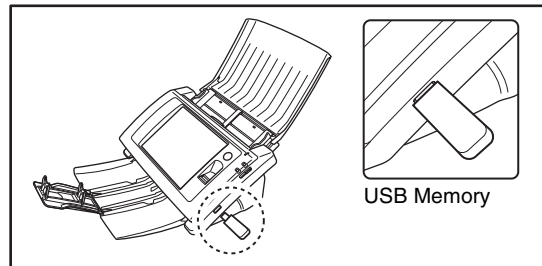

You can also connect a USB keyboard and USB mouse to operate the ScanFront.

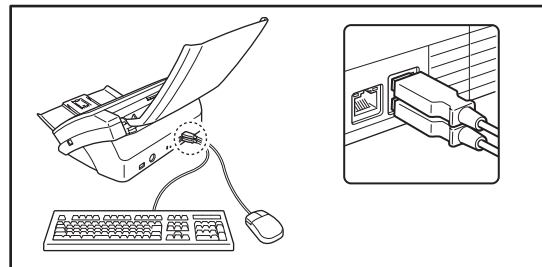

❗ IMPORTANT

- The scanner will not start if you turn the power ON while a USB memory device is inserted. Insert the USB memory device after the scanner has started up.
- Use USB memory that is not write-protected. If the USB memory is write-protected, data cannot be written to the USB memory.
- This scanner does not support USB memory equipped with password security, data encryption, or functions other than data storage.
- Make sure that the USB memory has sufficient space to store images.

3. Placing Documents

When placing documents into the scanner, place them face down into the tray with the top edge of the document at the bottom of tray.

□ Placing a Document

Follow the procedure below to place a document.

1. Adjust the document guides to be wider than the width of the document.

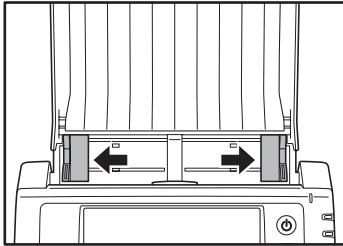

2. Fan the document to offset the pages so that the top edge of the first page is the lowest.

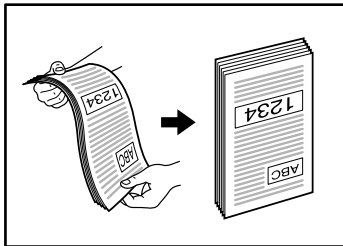

3. Place the document face down with its top edge at the bottom of the tray.

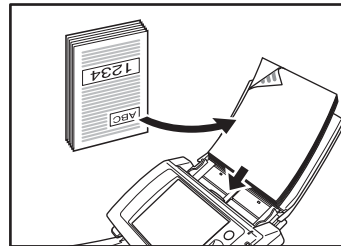

4. Adjust the document guides to fit the width of the document.

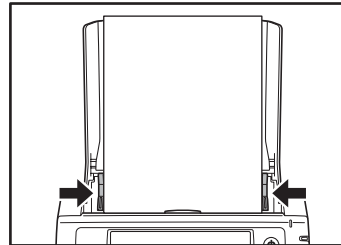

! IMPORTANT

Make sure that document stacks placed in the feed tray do not exceed the document guides.

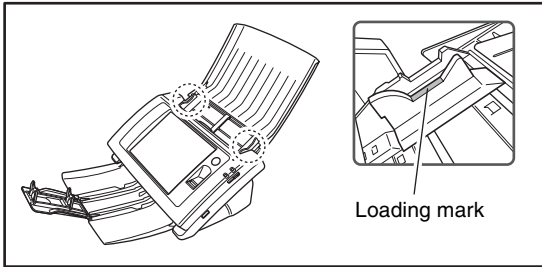

The number of sheets that you can place in the scanner at one time varies by paper size as follows.

Legal/A4 Size or Smaller:

50 sheets (stack 5 mm thick) or less

Sizes Larger than Legal/A4:

30 sheets (stacks 3 mm thick) or less

□ Placing a Folded Document

Folio Scan enables you to scan documents that are larger than Legal/A4 and therefore do not fit in the feeder. (The maximum size is 11" X 17"/A3.) To use the function, fold the document in half lengthwise and place it into the feeder. The ScanFront 300/300P will scan both sides and combine the scanned images into a single image.

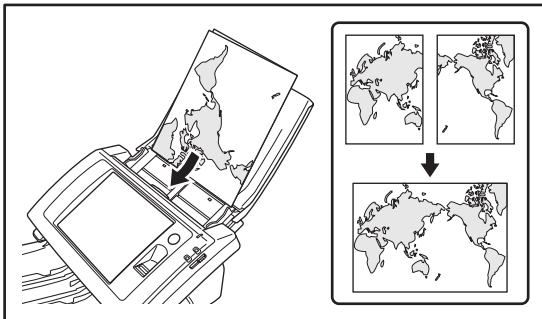

! IMPORTANT

- When folding the document, align the right and left sides and create a sharp, straight fold. Otherwise the document may jam or the image may not be aligned properly.
- The fold line itself will not be scanned. Keep this in mind if there is content such as photos, diagrams, or text that spans the fold.
- For Folio scanning, only the Page Separation OFF mode can be used. Place documents one at a time.
- Adjust the document guides to fit the width of the document. Otherwise, the image may scan as skewed or shifted.

💡 Hint

- When scanning folded documents, switch the feed selection lever to OFF. (See p. 2-5.)
- When placing folded documents, place the document into the scanner so that the fold is on the right side. The side of the folded document facing you will become the right side of the combined image.
- When scanning a document that is folded in half, set [Scanning Side] to [Folio].
- The maximum size for combined images is A3. When scanning a folded document of a size other than the standard formats, set [Page Size] to [Auto size].
- When scanning a document that is folded in half, set [Resolution (dpi)] to 300 dpi or less.
- When scanning a document that is folded in half, the [Double feed detection by Ultrasonic] function cannot be used.

□ Placing a Long Document

You scan documents up to 39.3" (1,000 mm) in length.

! IMPORTANT

- When scanning a long document, set [Page Size] to [Auto size (Long)].
- When scanning a long document, set [Resolution (dpi)] to 200 dpi or less.
- You cannot set [Scanning Side] to [Folio] when scanning a long document.

❑ Placing a Card

When you want to scan a card, follow the procedure below to place the card.

1. Move the feed selection lever upward (OFF).

❗ IMPORTANT

When scanning cards, set the feed selection lever to OFF and make sure to scan the cards one at a time.

2. Adjust the document guides to match the width of the card.

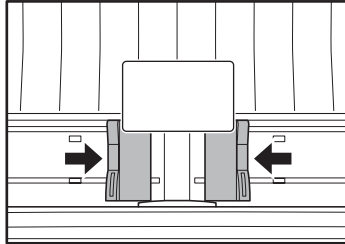

3. Place the card face down with the top edge at the bottom of the tray.

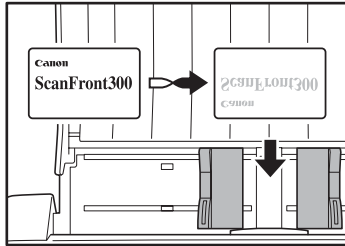

⚠ CAUTION

- A card placed into the document feed tray in the portrait orientation may not be output properly because a load is placed on it during feeding. Furthermore, removing a card that has caused a feeding error may damage the card, so make sure to correctly insert the card.
- Pull the lock lever and open the panel unit before removing a placed card. Inserting a finger into the scanner while the panel unit is closed may result in an injury.

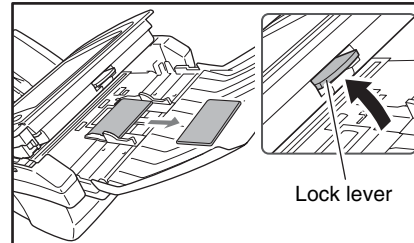

4. Clearing a Paper Jam or Double Feed Error

When a paper jam or double feed error is detected, feeding and scanning stops.

1. Check the displayed message.

If a paper jam or double feed error is detected at the first page of a document, the following messages appear.

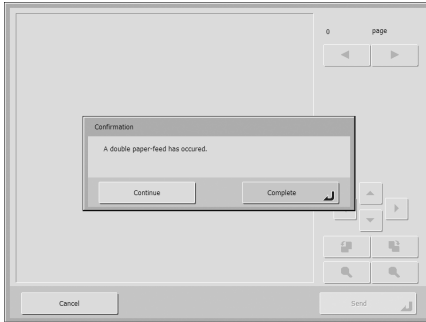
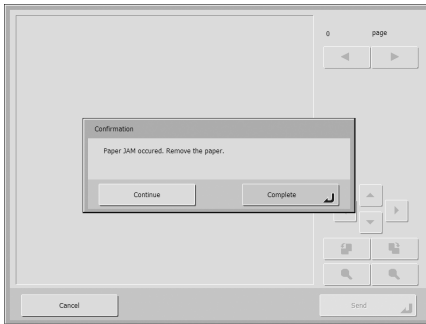

Hint

- If you press [Complete], the display returns to the previous screen.
- If you want to continue scanning, reset the document before progressing with screen operations. Press [Continue] to resume scanning.

If a paper jam or double feed error is detected in the middle of a document, the following messages appear.

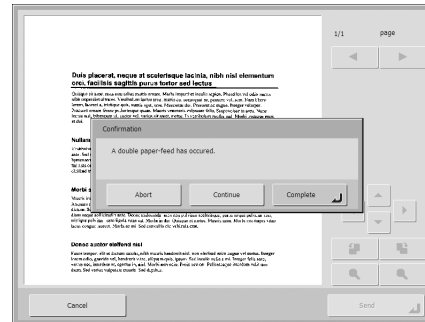
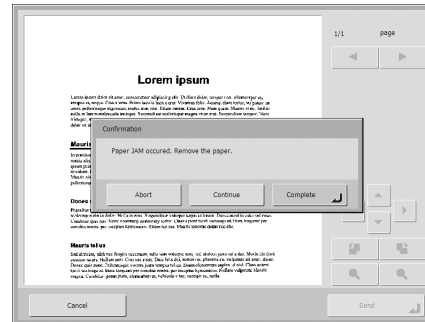

Hint

- If you press [Abort], the scanned images are canceled, and the display returns to the previous screen.
- If you want to continue scanning, clear the document first before touching the screen. After you reset the cleared document, press [Continue] to resume scanning.
- If you press [Complete], the scanned images up until the paper jam or double feed error are saved and scanning completes. The display switches to the Send screen.

! IMPORTANT

When the message above is displayed and the scanner transitions to Low Power Mode, all of the data scanned up until that point is discarded. (See p. 3-3.)

2. Remove the scanned documents from the document eject tray, and any documents remaining in the document feed tray.
3. Pull the lock lever toward you and then fully open the panel unit.

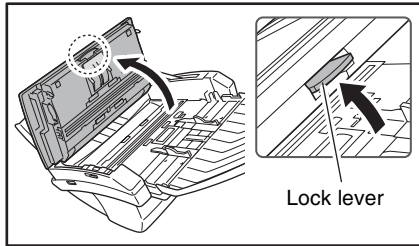

! CAUTION

The open/close movement of the panel unit is linked to the up/down movement of the document eject tray. Do not press on the document eject tray when you open the panel unit.

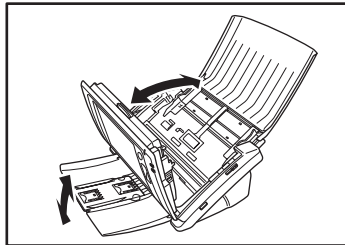

4. Pull out the jammed document in the direction that seems the easiest to remove it.

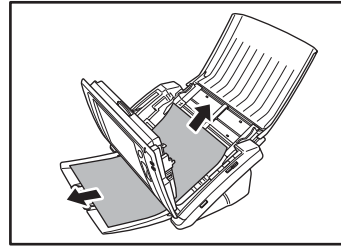

5. Close the panel unit and then place the document again.

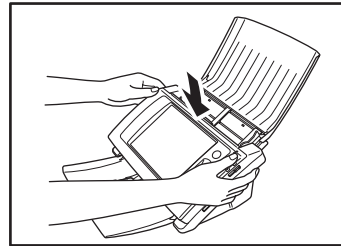

6. Press [Continue] to resume scanning.

! IMPORTANT

- If double feed errors occur repeatedly, reduce the number of sheets you place in the document feed tray to about 10.
- A dirty or worn feed roller, or documents stuck together as a result of static electricity are common causes of paper jams or double feed errors.

If the feed roller is dirty, clean it. If paper jams or double feed errors continue to occur even after cleaning, purchase an Exchange Roller Kit and replace the rollers (feed roller and retard roller), and document holding guides.

5. Fingerprint Sensor (ScanFront 300P)

The ScanFront 300P is equipped with a fingerprint sensor for registering fingerprints and authenticating users. The fingerprint sensor is a precision component. Be careful when handling this sensor.

❑ Cautions for Handling the Fingerprint Sensor

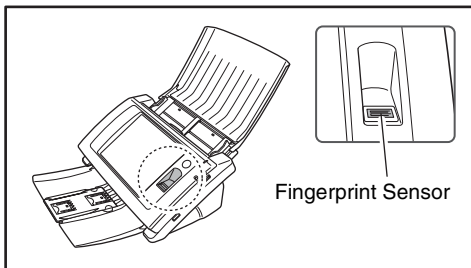

- The following actions may damage the fingerprint sensor or cause it to malfunction. Read this information carefully to avoid damaging the sensor.
 - Dropping an object on the fingerprint sensor, or otherwise subjecting it to a strong impact
 - Scratching the surface of the fingerprint sensor, or poking it with a pointed object
 - Pressing a hard object such as a fingernail or metal item against the fingerprint sensor
 - Touching the fingerprint sensor with dirty hands
 - Placing a sticker on the surface of the fingerprint sensor, or covering the surface with ink or another substance
 - If fingerprint authentication fails frequently, the fingerprint sensor may be dirty. Clean the surface of the fingerprint sensor regularly.
 - When cleaning the fingerprint sensor, use a soft dry cloth to wipe dirt off the surface.
- Do not use a pointed object to remove any dirt that accumulates around the fingerprint sensor. Doing so may cause the fingerprint sensor to malfunction.
 - Touching the fingerprint sensor while charged with static electricity may cause the fingerprint sensor or scanner unit to malfunction. Before touching the fingerprint sensor, discharge any static electricity by touching a piece of metal. Be especially careful during dry periods, such as the winter season, when the likelihood of being charged with static electricity is high.

❑ Fingerprint Authentication

- Follow the procedure below to use fingerprint registration and authentication.
 1. Align the first joint of a finger on the sensor and press the finger on the fingerprint sensor.
 2. Keep the finger pressed while slowly sliding it straight at a constant speed to scan the fingerprint.

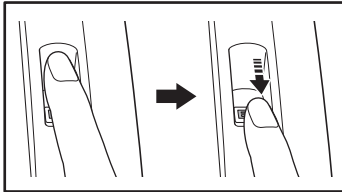

- Fingerprint authentication uses the unique information of fingerprints. The fingerprint authentication function may not work properly for a finger with a fingerprint that is worn down or has few distinguishable features.
- The same finger needs to be scanned three times to register the fingerprint.
- The authentication performance differs depending on the condition of the fingerprint when it is registered and when it is authenticated. The following conditions may cause an error in fingerprint authentication:
 - The finger is wet or sweaty
 - The finger is dirty
 - The grooves of the fingerprint are filled with sweat or oil
 - The finger is dry (dry skin)
 - Part of the fingerprint is missing because of, for example, a wound or burn injury
 - The fingerprint has worn thin

- Authentication performance may improve if the condition of the fingerprint is improved as a result of washing your hands or applying hand cream.
- Authentication may not be performed properly depending on the speed with which you slide your finger over the sensor. In this case, adjust the speed with which you slide your finger in accordance with the message that appears.
- Fingerprint authentication does not necessarily guarantee the authentication and verification of the identity of a person.

Hint

For details on the procedures for fingerprint registration and authentication, see Chapter 3 “Operating Procedures”.

Chapter 3 Operating Procedures

1. Flow of Scanner Operations	3-2	7. Scanning Procedures	3-13
2. Turning the Power ON and OFF	3-3	Scanning From the Home Screen	3-13
Turning the Power ON	3-3	Scanning From the Job Button Screen	3-14
Turning the Power OFF	3-3	Address Selection Screen	3-15
3. Login Screen	3-4	USB Memory Screen	3-16
Login Screen Types	3-4	Print Settings Screen	3-17
When Using Server Authentication	3-4	Scanning	3-18
List Type Login	3-5	8. Registering and Editing Addresses	3-22
Key in Type Login	3-6	Registering a New Address	3-22
Fingerprint Authentication (Only Available with the ScanFront 300P)	3-7	Modifying an Address	3-25
4. Screen Displayed after Login	3-8	Copying an Address	3-25
Home Screen	3-8	9. Scan/Delivery Options	3-27
Job Button Screen	3-8	Scan Settings	3-28
5. User Settings Screen	3-9	File Formats	3-32
Change Password	3-9	Security Settings for PDF Files	3-33
Fingerprint Registration	3-9	Delivery Options	3-34
6. Fingerprint Registration (Only Available with the ScanFront 300P)	3-10		
Fingerprint Authentication	3-10		
Registering a Fingerprint	3-11		

2. Turning the Power ON and OFF

Use the power switch to turn the scanner ON, and press the [Power off] button on the touch panel to turn it OFF.

□ Turning the Power ON

Press the power switch to turn the scanner ON. The power indicator lights, and the Home screen or the login screen appears.

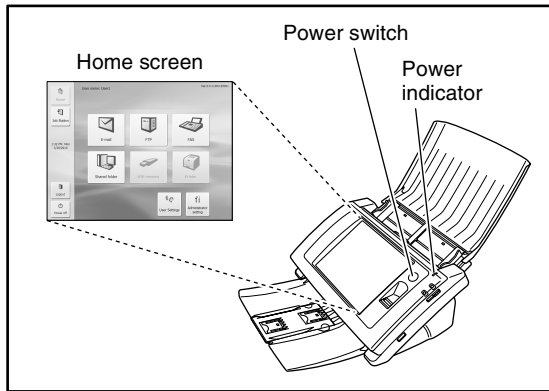

💡 Hint

- It takes approximately 40 seconds for the Home screen to appear after the power switch is turned on.
- If users have been registered, the login screen appears. (See "Login Screen" on p. 3-4.)
- When the power indicator is lit but nothing appears on the touch panel, Display Off has activated to turn the panel display off. You can touch the panel to restore the display.
- When the power indicator is flashing but nothing appears on the touch panel, the Low Power mode has activated to temporarily stop scanner operations. To switch out of Low Power mode, press the power switch or touch the touch panel.
- Contact the ScanFront administrator for details on the Display off mode and Low Power mode settings.

□ Turning the Power OFF

Press the [Power off] button displayed at the bottom left of the panel to turn the scanner OFF.



⚠ IMPORTANT

- When restarting the scanner, wait at least 5 seconds after turning the power OFF before turning it ON again.
- If the scanner stops responding, press and hold the power switch to shut down the system, and then press the power switch to turn the scanner ON again. In such cases, settings configured immediately before shutting down may be lost.

3. Login Screen

The login screen appears at the startup when the scanner is turned ON.

□ Login Screen Types

There are two types of login screen: a list type login screen for selecting from a list of registered users, and a key in type login screen for entering a user name and password.

List Type Login Screen

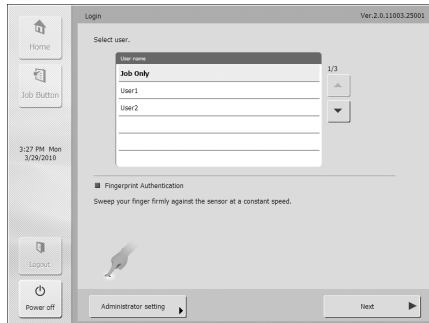

Key in Type Login Screen

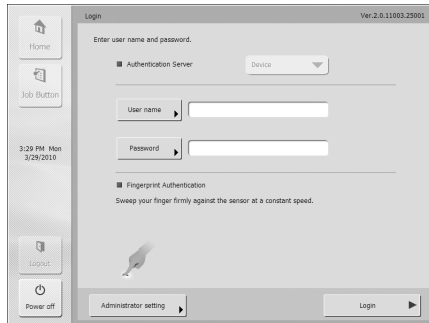

💡 Hint

- Set the type of login screen from [Device Operation] of the Web menu (refer to p. 6-31 on the *ScanFront 300/300P INSTRUCTIONS*) or [Login type setting] in the administrator settings of the ScanFront (refer to p. 3-10 on the *ScanFront 300/300P INSTRUCTIONS*).
- Fingerprint authentication is enabled when you are using the ScanFront 300P. (See “Fingerprint Authentication (Only Available with the ScanFront 300P)” on p. 3-7.)

□ When Using Server Authentication

The login screen when you use server authentication is a key in type, and a list box is displayed for selecting Device Authentication and Server Authentication.

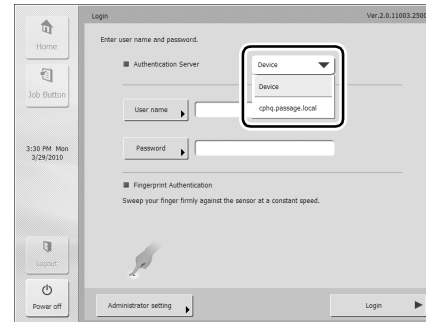

❗ IMPORTANT

When you use server authentication to log in, you are registered as a new user of server authentication.

❑ List Type Login

Use the procedure below to log in to the list type login screen.

1. Select the user to log in as from the list, and then press [Next].

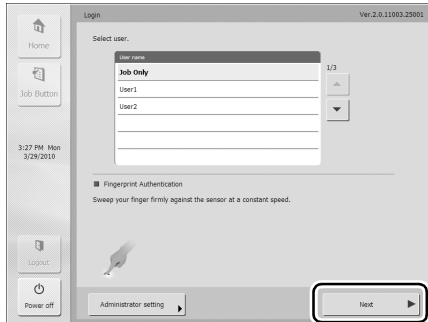

The password input screen appears.

2. Press [Password].

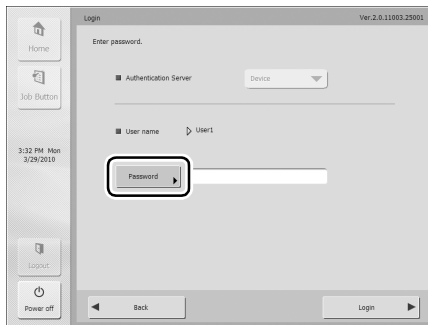

The keyboard screen appears.

3. Enter a password and then press [OK].



❗ IMPORTANT

Passwords are case-sensitive. Make sure to enter the password correctly.

4. Press [Login] to log in to the scanner.

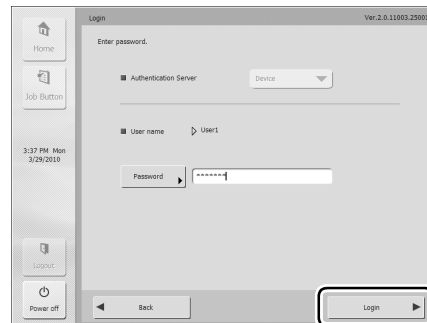

5. The Home screen (or Job Button screen) appears.

❑ Key in Type Login

In the key in type login screen, enter your user name and password to log in.

1. Press [User name] ([Password]).

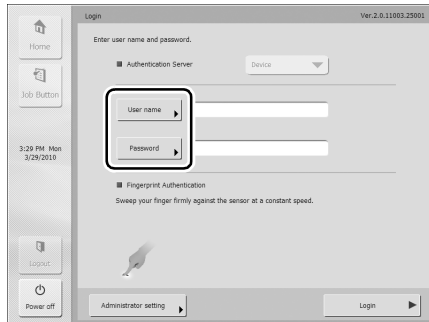

The keyboard screen appears.

2. Enter your user name (password) and then press [OK].



! IMPORTANT

- User names and passwords are case-sensitive. Make sure to enter the user and password registered during device authentication correctly.
- If you do not know the user name and password registered for server authentication, contact the domain server administrator.

3. Press [Login] to log in to the scanner.

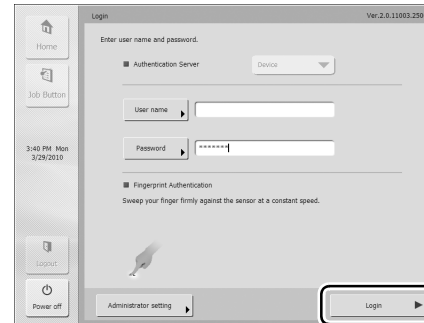

4. The Home screen (or Job Button screen) appears.

❑ Fingerprint Authentication (Only Available with the ScanFront 300P)

Use the procedure below for fingerprint authentication. For details on fingerprint registration, see “Fingerprint Registration (Only Available with the ScanFront 300P)” on p. 3-10.

1. Perform fingerprint authentication using the finger with the registered fingerprint.

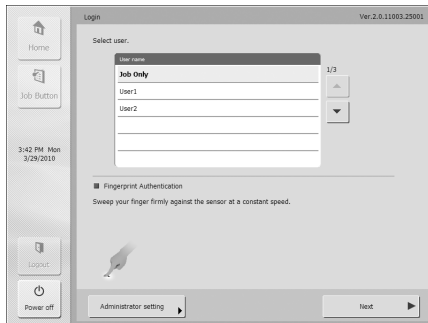

! IMPORTANT

Perform finger authentication by gently pressing the finger while slowly sweeping it at a constant speed to scan the fingerprint.

2. The Home screen (or Job Button screen) appears if the fingerprint is authenticated correctly.

💡 Hint

- When fingerprint authentication fails, the cause of the failure and a solution appear on the screen. Follow the instructions in the solution, and perform fingerprint authentication again.

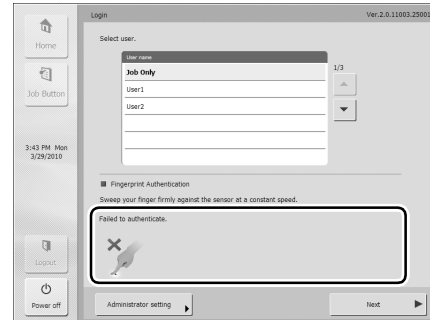

- If a user fingerprint is registered for server authentication, and the user password is changed on the server while the user is logged in via fingerprint authentication, the following message will appear on the screen. In this case, without using fingerprint authentication, enter your user name and changed password to log in, and then re-register your fingerprints.

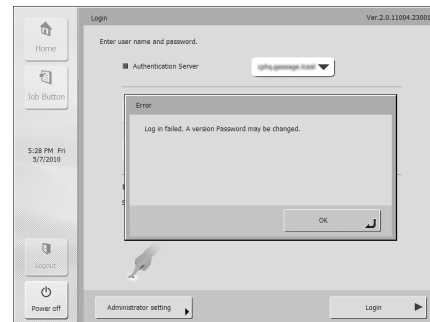

4. Screen Displayed after Login

You can set the screen (Home screen or Job Button screen) that is displayed after a user logs in. (See p. 4-4.)

□ Home Screen

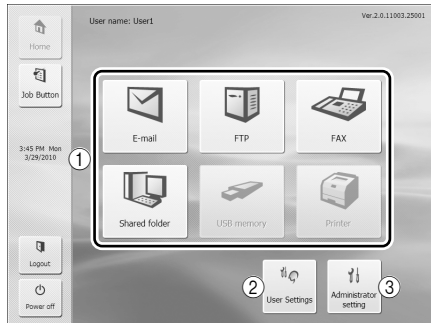

- ① Select destination (E-mail, FTP, FAX, Shared folder, USB memory, and Printer) buttons
These buttons open an address selection screen. (See “Scanning Procedures” on p. 3-13.)



Hint

- The USB memory button is enabled when USB memory is inserted in a USB port.
 - [Printer] is enabled when the ScanFront is connected to a network environment that is running ScanFront Service.
- ② [User settings] button
Enables setting of the user password and fingerprint registration (only with the ScanFront 300P). (See “User Settings Screen” on p. 3-9.)
 - ③ [Administrator setting] button
Opens the Administrator Settings screen.



IMPORTANT

If a user whose use of the Home screen is restricted logs in, the Home screen is not available. For details, contact the administrator.

□ Job Button Screen

This screen enables you to select a job button to scan using the conditions registered to the job button, and then send the image file. (See “Scanning Procedures” on p. 3-13.)



IMPORTANT

- The document is scanned immediately after you press the job button. Make sure to place your document before you press the job button. (See “Placing Documents” on p. 2-6.)
- Perform job button registration and editing via the Web menu.
- If you are unable to edit a job button, the editing of job buttons has been restricted by the ScanFront administrator. For details, contact the administrator.

5. User Settings Screen

The User Settings screen enables you to edit the user password and register a fingerprint (only available with the ScanFront 300P).

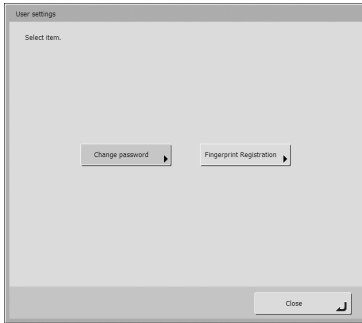

Change Password

You can register a new user password or change a user password registered via the Web menu.

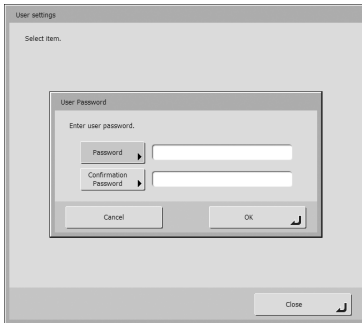

Hint

The old password does not need to be entered in order to change a password. The new password that you entered is registered.

Fingerprint Registration

Fingerprint registration is enabled when you are using the ScanFront 300P. For details on fingerprint registration, see “Fingerprint Registration (Only Available with the ScanFront 300P)” on p. 3-10.

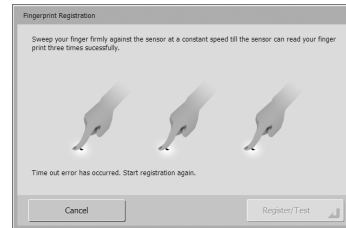

6. Fingerprint Registration (Only Available with the ScanFront 300P)

Fingerprint authentication is a function for registering the fingerprints of users that will log in when the device authentication or server authentication method is used, and enables users to log in by authenticating their fingerprints. When fingerprint authentication is used, there is no need to select a user in the list type login screen or enter a user name and password in the key in type login screen. For details on handling the fingerprint sensor, see “Fingerprint Sensor (ScanFront 300P)” on p. 2-11.

□ Fingerprint Authentication

- Follow the procedure below to use fingerprint registration and authentication.
 1. Align the first joint of a finger on the sensor and press the finger on the fingerprint sensor.
 2. Keep the finger pressed while slowly sliding it straight at a constant speed to scan the fingerprint.

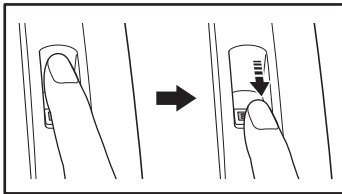

- Fingerprint authentication uses the unique information of fingerprints. The fingerprint authentication function may not work properly for a finger with a fingerprint that is worn down or has few distinguishable features.
- The same finger needs to be scanned three times to register the fingerprint.
- The authentication performance differs depending on the condition of the fingerprint when it is registered and when it is authenticated. The following conditions may cause an error in fingerprint authentication:
 - The finger is wet or sweaty
 - The finger is dirty
 - The grooves of the fingerprint are filled with sweat or oil
 - The finger is dry (dry skin)
 - Part of the fingerprint is missing because of, for example, a wound or burn injury
 - The fingerprint has worn thin
- Authentication performance may improve if the condition of the fingerprint is improved as a result of washing your hands or applying hand cream.
- Authentication may not be performed properly depending on the speed with which you slide your finger over the sensor. In this case, adjust the speed with which you slide your finger in accordance with the message that appears.
- Fingerprint authentication does not necessarily guarantee the authentication and verification of the identity of a person.

❑ Registering a Fingerprint

Register a fingerprint from the User Settings screen accessed from the Home screen.

! IMPORTANT

If the Home screen is not displayed, use of the Home screen has been restricted for the user by the ScanFront administrator. Confirm this with the administrator.

1. Press [User settings].

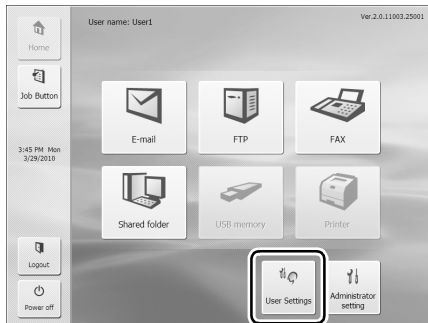

The User Settings screen appears.

2. Press [Fingerprint Registration].

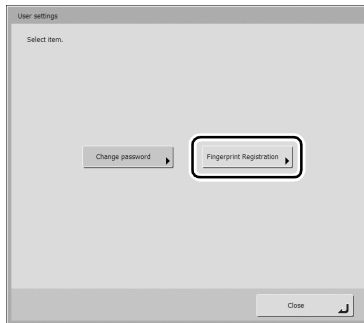

The Fingerprint Registration screen appears.

3. Scan your fingerprint.

Repeat scanning until the same fingerprint has been successfully scanned three times.

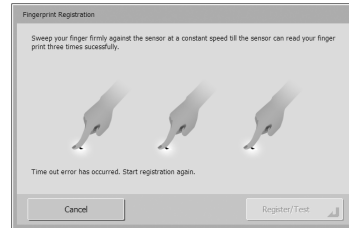

! IMPORTANT

- If any of the messages below appears, there was an error scanning the fingerprint. Try scanning your fingerprint again.
 - Failed to read fingerprint. Please try again.
 - Sweep speed was too fast. Please sweep more slowly.
 - Sweep speed was too slow. Please sweep more faster.
- If any of the messages below appears, start fingerprint registration again from the beginning.
 - Can not verify the fingerprint data. Start registration again.
 - Time out error has occurred. Start registration again.

4. After you have successfully scanned your fingerprint three times, press [Register/Test].



The Test Mode screen appears.

5. Perform an authentication test for the registered fingerprint by scanning your fingerprint.

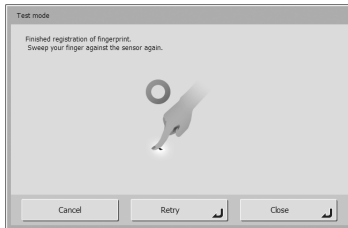

6. Press [Close] to end fingerprint registration.

! IMPORTANT

If you want to change the registered fingerprint, start registration again from the beginning.

7. Scanning Procedures

You can perform scanning from the Home screen or the Job Button screen.

□ Scanning From the Home Screen

Press a destination selection (E-mail, FTP, Fax, Shared folder, or USB memory) button to open an address selection screen and then select an address to send an image file.

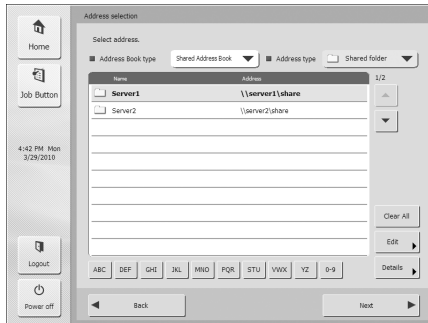

If you press the USB memory destination selection button, press [Downward] and specify the folder in the USB memory to which you want to save the image file.

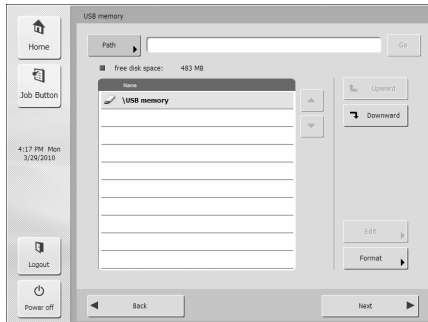

If you press the Printer destination selection button, configure the printer settings.

! IMPORTANT

If the network environment to which the ScanFront is connected is not running ScanFront Service, [Printer] is grayed out and cannot be selected.

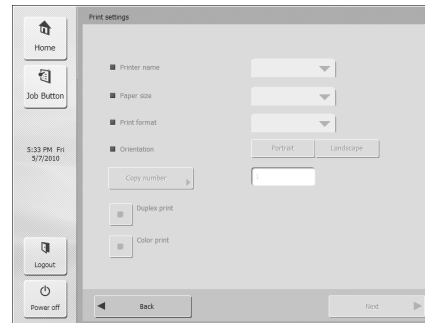

If you select an address and then press [Next], the Scan/Delivery Options screen appears. Set the scanning conditions and then start scanning.

❑ Scanning From the Job Button Screen

If you press a job button, the Scan/Delivery Options screen appears. Confirm the address and scanning settings registered to the job button and then start scanning. For details on the scanning procedure, read from the setting of scanning conditions in Step 5.

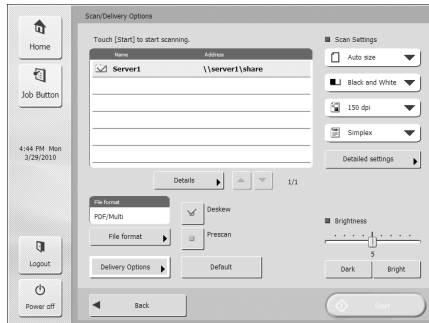

! IMPORTANT

- The settings screen display and the screen displayed after scanning differ depending on the job button settings. For details on the overall flow from configuring settings to sending an image file, see “Flow of Scanner Operations” on p. 3-2.
- Job buttons cannot be used to save image files to USB memory or send them to printers for printing.

❑ Address Selection Screen

From the address selection screen, you can select the address to send an image file and register addresses.

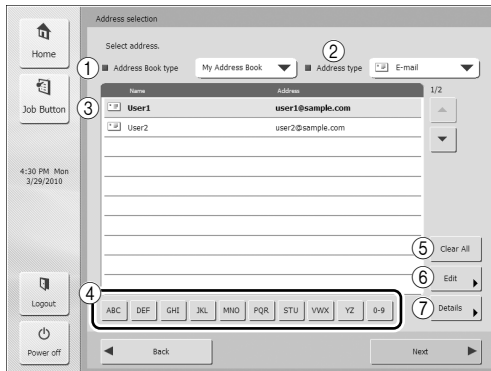

① Address Book type

Selects the address book type (Shared Address Book or My Address Book). If the address book server setting is enabled, [LDAP Address Book] is added.

② Address type

If you select the type of address (e-mail, fax, shared folder, FTP, and groups) to display in the address list, addresses of the selected type are displayed.

③ Address List

Displays registered addresses and enables you to select the address to send an image file.

Hint

- The following icons are used to indicate the types of address.
 - :E-mail
 - :Shared folder
 - :Fax
 - :FTP
 - :Group
- Pressing an address adds a checkmark () to the icon and selects the address. Pressing a selected address again clears the selection.
- An address is not selected as an address if there is no checkmark added to the icon, even if the background of the address is colored and the address appears selected.

- Each time you press an e-mail or group icon, the send condition changes (To, Cc, Bcc).
 - :To
 - :Cc
 - :Bcc
 - :Selection cleared

④ Jump Keys

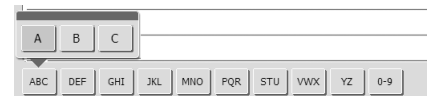

If there are many addresses and the address you want is not displayed in the address list, you can use these keys to specify a keyword to search for and display the address.

⑤ [Clear All] button

Clears all address selections.

⑥ [Edit] button

Enables you to register new addresses and edit addresses.

⑦ [Details] button

Displays detailed information for the address.

❑ USB Memory Screen

The USB Memory screen enables you to specify the folder in the USB memory to save the image file.

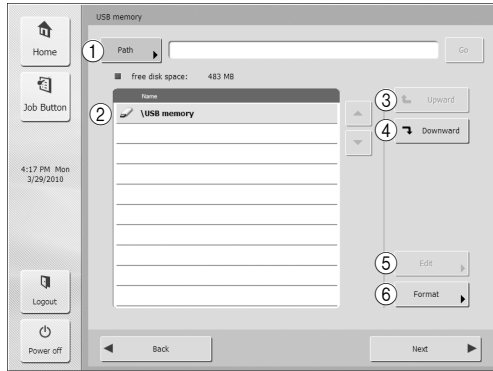

① Path

Enter the folder path of the USB memory. You can also press [Downward] to select a folder.

② USB Memory Display

Displays the inserted USB memory.



Hint

- If you insert two or more USB memory sticks, numbers are allocated to sticks from the second one onwards. For example, the first one that was inserted is displayed as “USB memory”, and the second one inserted is displayed as “USB memory 2”.

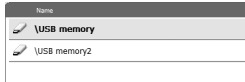

- If you want to insert or replace a USB memory stick while the USB memory screen is open, press the [Back] button to return to the Home screen, update the USB memory information, and then reopen the USB memory screen.

③ [Upward] button

Enables you to move to a higher level folder when a lower level folder is selected in the memory.

④ [Downward] button

Enables you to move to a lower level folder in the USB memory.

⑤ [Edit] button

Enables you to register new folders and edit folders.

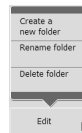

⑥ [Format] button

Enables you to format the USB memory.

Print Settings Screen

The print settings screen enables you to specify the printer, paper size, and other print settings.

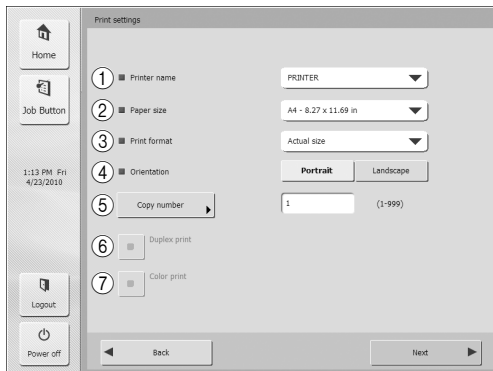

① Printer name

Select the printer that will be used to print the scanned images. Printers that are compatible with the ScanFront Service Server can be selected.

② Paper size

Select the paper size.

③ Print format

Specify the method in which the scanned image is scaled for printing.

- Actual size
Prints the scanned image in the same size as the original document.
- Fit to paper
Prints while expanding or reducing the scanned image to fit the paper size.
- Actual pixel
Prints while matching the resolution of the scanned image.

④ Orientation

Press [Portrait] or [Landscape] to specify the orientation for printing.

⑤ Copy number

Specify the number of copies to print.

⑥ Duplex print

When you want to perform duplex printing, light this button by pressing it.

⑦ Color print

When you want to perform color printing, light this button by pressing it.

! IMPORTANT

The print settings you can configure will vary depending on your printer. Settings and functions that are not supported by your printer cannot be configured in this screen.

❑ Scanning

This section describes the procedure for scanning. If you want to save the image file to USB memory, specify the folder in the USB memory to save the image file in Steps 2 to 4. (See “USB Memory Screen” on p. 3-16.)

1. Select a destination.

Press a destination button to select a destination.

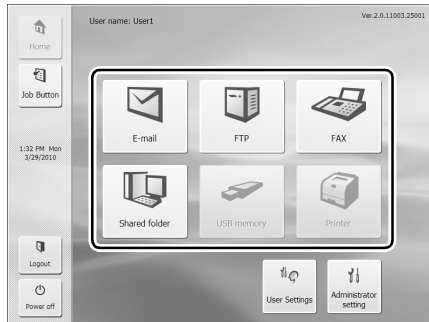

The address selection screen appears.

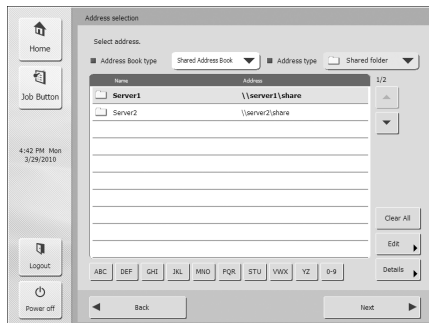

2. Use [Address Book type] and [Address type] to display the address to send the image file.

3. Press a displayed address to select it.

A checkmark (☑) is added to the icon for the selected address. Pressing a selected address again clears the selection.

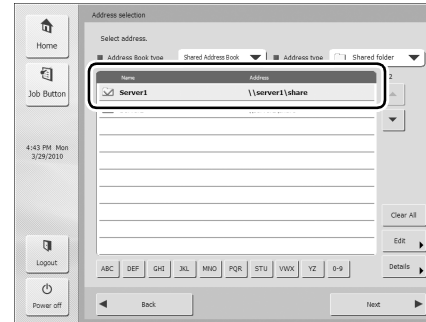

! IMPORTANT

An address is not selected as an address to send data to if there is no checkmark, even if the background is shaded.

4. Make sure the selected address has a checkmark and then press [Next].

💡 Hint

When a different type of address is selected, you can confirm the selected address by pressing [Selected address] in the Address type drop-down list.

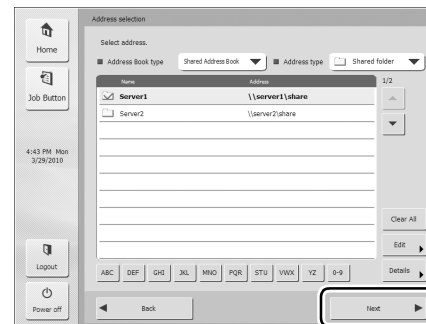

The Scan/Delivery Options screen appears.

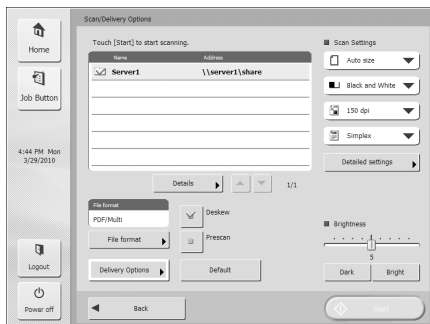

5. Set the scan conditions. (See “Scan/Delivery Options” on p. 3-27.)

IMPORTANT

When you use a job button for scanning, the subsequent procedure varies as follows in accordance with the job button settings. For details, see “Registering New Job Buttons” on p. 4-17.

- If [When you select this Job Button] is set to [Skip Scan Setting Screen] and you press a job button, scanning is started without displaying the Scan/Delivery Options screen of Step 4.
- If [Send the files immediately after scanning] is set to [ON], scanning ends without displaying the continue to scan confirmation screen of Step 7 and then the address confirmation screen of Step 10 appears.
- If [Confirm addresses before sending] is set to [OFF], the image is sent without displaying the address confirmation screen of Step 10 and the operation ends.

6. Press [Start] to start scanning.
Scanning stops after the document has been scanned.

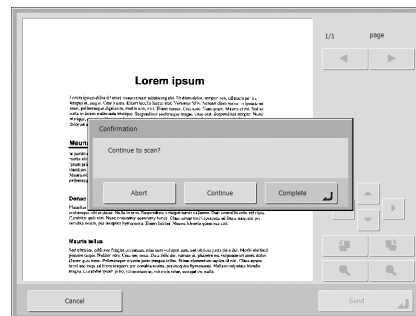

IMPORTANT

- If [Send the files immediately after scanning] is set to [ON] in Delivery Options of the Scan/Delivery Options screen, scanning ends without displaying the continue to scan confirmation screen, and the address confirmation screen of Step 10 appears.
- When the confirmation message is left displayed and the scanner transitions to Low Power Mode, all of the data scanned up until that point is discarded. (See p. 3-3.)



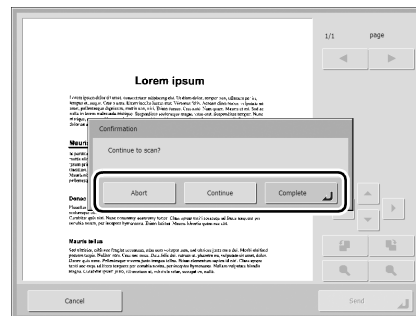



7. Check the document and go to the next step.



- Press [Abort] to cancel the scanned images and return to the Scan/Delivery Options screen.
- Press the [Continue] button to resume scanning.
- Press [Complete] to go to the Send screen.

8. Check the scanned images.



-  : Display the image of the next page.
-  : Display the image of the previous page.
-  : Move the viewing area around an image when an enlarged view of the image is shown.
-  : Rotate the image 90 degrees counterclockwise.
-  : Rotate the image 90 degrees clockwise.
-  : Enlarge the image.
-  : Reduce the image.



Hint

When the preview image is enlarged, you can drag your finger on the image to scroll.

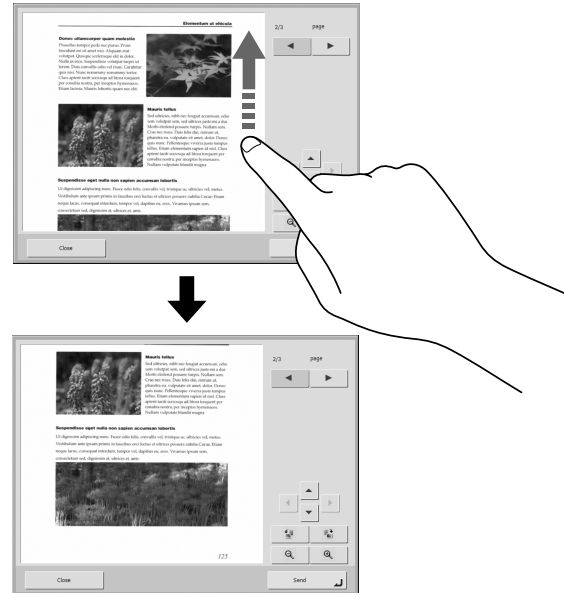

9. Press [Send].



The address confirmation message appears.

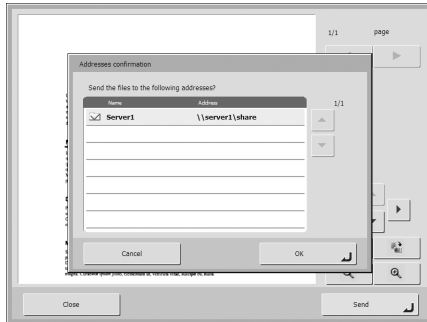

! IMPORTANT

If [Confirm addresses before sending] is set to [OFF] in Delivery Options of the Scan/Delivery Options screen, the image is sent without displaying the address confirmation screen and the operation ends.

10. Confirm the address and press [OK] to send the scanned image.

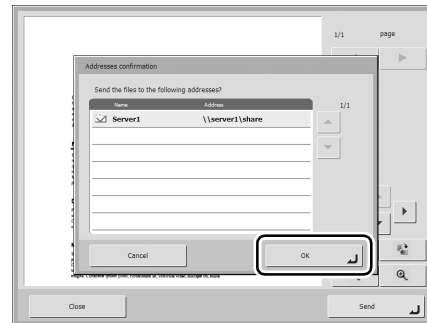

! IMPORTANT

If a send error message appears, check the address settings and send destination and try again.

11. Returns to the screen set for [Screen after sending] in Delivery Options of the Scan/Delivery Options screen.

8. Registering and Editing Addresses

If an address to which you want to send an image file is not registered in the address book or the information of a registered address has not been updated, use the procedure below to register a new address or modify an address in the address book.

□ Registering a New Address

1. Make selections for [Address Book type] and [Address type], press [Edit], and then press [New].

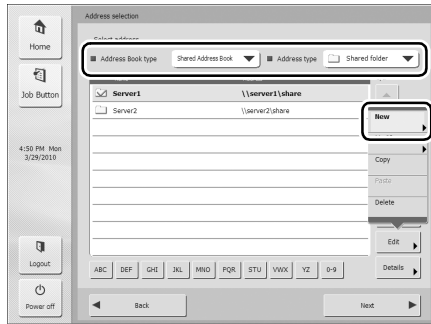

2. Register the address in accordance with the setting conditions of the address type.

E-mail Registration Screen

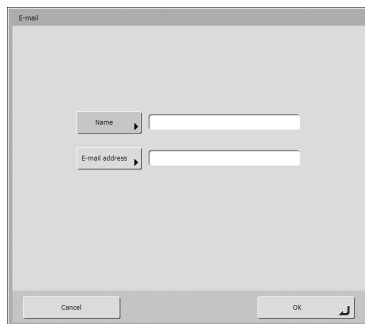

- Name
Enter the name to appear in the address book.
- E-mail address
Enter the sender's address for when image files are sent by e-mail.

Shared Folder Registration Screen

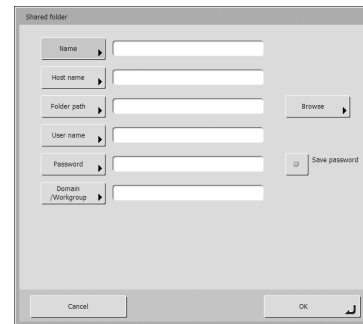

- Name
Enter the name to appear in the address book.
- Host name
Enter the name of the computer containing the publicly shared folder. When the ScanFront Service is running, you can enter the IP address instead of a host name.
- Folder path
Enter the name of the shared folder and the path of the sub-folder to register.

 **Hint**

If the path of the sub-folder is unknown, use the procedure below to specify the sub-folder.

1. Enter the host name, user name, password, and domain, and then press [Browse] to access the computer that is making the shared folder public.
Sub-folders on computers running Windows 7 or Windows Server 2008 R2 cannot be browsed by pressing the [Browse] button. In such cases, enter the computer name and path up until the top-most folder of that computer in [Folder path], and then press [Browse].
 2. Specify any sub-folder within the displayed folder.
 3. Press [Downward] to move to a level lower than the selected folder, or press [Edit] and [Create a new folder] to create a new folder.
- **User name/Password**
Enter the user name and password of an account with write permission for the shared folder.
 - **Domain/Workgroup**
If the computer containing the shared folder is part of a domain, enter the domain name.
 - **Save password**
Save the entered password.

FTP Registration Screen



- **Name**
Enter the name to appear in the address book.
- **FTP server**
Enter the address of the FTP server.
- **Folder path**
Enter the path of the sub-folder when specifying a sub-folder on the FTP server.

 **Hint**

If the path of the sub-folder is unknown, use the procedure below to specify the sub-folder.

1. Enter the server address, user name, and password, and click [Browse] to log in to the FTP server.
 2. Specify any sub-folder at the level of the displayed folder and click [OK].
- **User name/Password**
Enter the user name and password for logging in to the FTP server.

 **IMPORTANT**

Enter the user name and password of an account with write permission for the FTP server.

- **Port number**
Enter the port number. The standard port number is 21.
- **Save password**
Save the entered password.
- **Use passive mode**
Use passive mode for sending to the FTP server.

 **IMPORTANT**

Use passive mode when normal communication with the FTP server cannot be established. However, be aware that communication may not be possible if the network is not functioning properly.

Fax Registration Screen

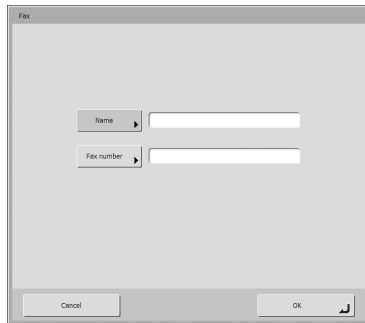

The Fax Registration Screen is a dialog box with a title bar labeled "Fax". It contains two input fields: "Name" and "Fax number", each with a dropdown arrow on the left. At the bottom, there are "Cancel" and "OK" buttons.

- Name
Enter the name to appear in the address book.
- Fax number
Enter the recipient fax number.

Group Registration Screen

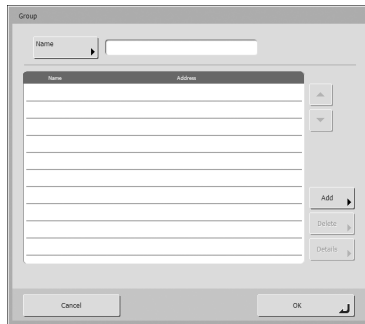

The Group Registration Screen is a dialog box with a title bar labeled "Group". It has a "Name" input field with a dropdown arrow. Below it is a table with two columns: "Name" and "Address". The table has several empty rows. To the right of the table are "Add", "Delete", and "Details" buttons. At the bottom, there are "Cancel" and "OK" buttons.

- Name
Enter the name that you want to appear in the address book.

- [Add] button
Select addresses to register to the group from [Address Book type] and [Address type]. The selected addresses are displayed in the list.

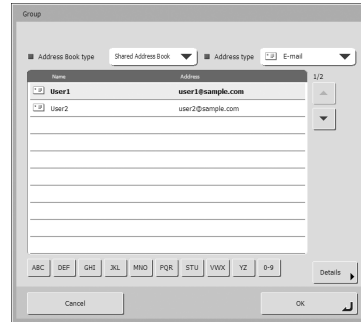

The Group Registration Screen is shown with a list of addresses. The title bar is "Group". At the top, there are dropdown menus for "Address Book type" (set to "Shared Address Book"), "Address type" (set to "E-mail"), and "E-mail". Below these is a table with two columns: "Name" and "Address". The table contains two rows: "user1" with "user1@sample.com" and "user2" with "user2@sample.com". To the right of the table are "Add" and "Delete" buttons. Below the table are buttons for "ABC", "DEF", "GHI", "JKL", "MNO", "PQR", "STU", "VWX", "YZ", and "0-9". A "Details" button is also present. At the bottom, there are "Cancel" and "OK" buttons.

! IMPORTANT

- When you add shared folders to groups, do not add multiple shared folders with different access privileges to one group.
- Using a group to simultaneously send to shared servers and the like and multiple shared folders with different access privileges may result in a send error.

❑ Modifying an Address

Modify an address when there is a send error because the information of the transfer destination registered for the address is wrong or has been changed.

1. Select the type of the address to modify and press [Details].

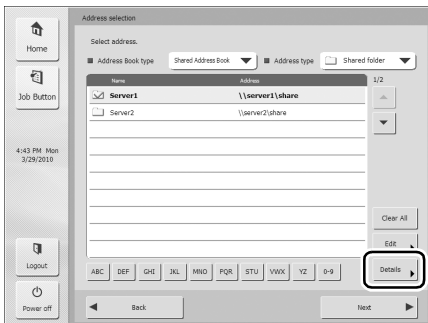

Detailed information for the address appears.

2. Check the detailed information for the selected address.
3. Press [Edit], and then press [Modify].

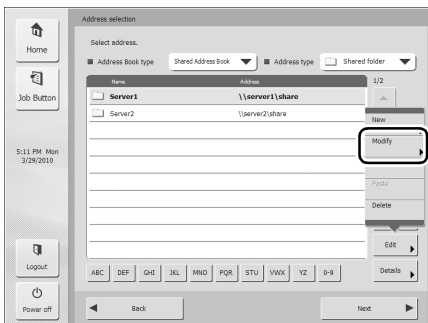

The edit screen for the address appears.

4. Modify the address.



Hint

For details on editing items, see “Registering a New Address” on p. 3-22.

❑ Copying an Address

You can copy addresses between My Address Book and Shared Address Book.

1. Select the address book entry to copy.
2. Select the address, press [Edit], and then press [Copy].

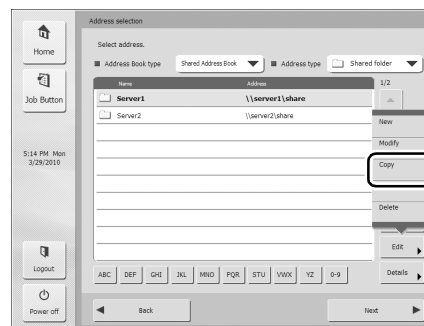

The selected address is copied to memory.

3. Select the address book type, press [Edit], and then press [Paste].

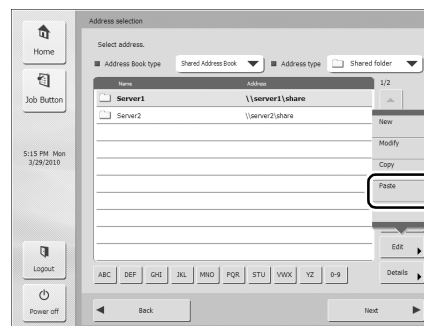

A confirmation message appears.

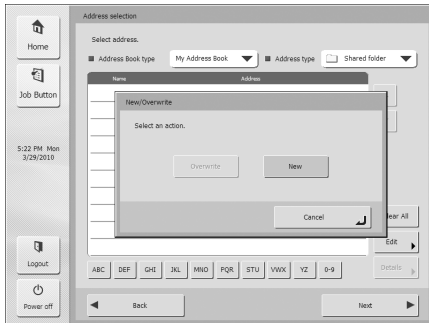

4. Press [New] and paste the address.



Hint

If the address book already has an address with the same name as the pasted one, the following message appears.

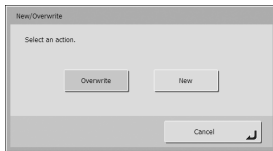

- If you select [New], an address with the same name is created in the address book.
- If you select [Overwrite], the existing address with the same name is overwritten.

9. Scan/Delivery Options

This section describes the scan settings and send settings for the scanner.

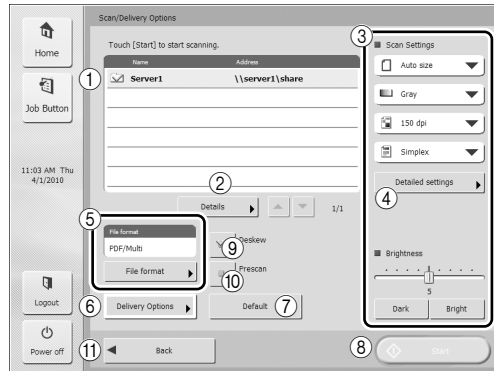

① Address Display Area

Displays the selection that you made on the address selection screen or the addresses registered to the job button.

② Details

Displays detailed information for the address with the colored background.

③ Scan Settings

Sets the scan conditions. (See “Scan Settings” on p. 3-28.)

④ Detailed settings

Configures detailed settings for scan conditions. (See “Detailed Settings” on p. 3-29.)

⑤ File format

Checks the displayed file format and press the [File format] button to configure the settings. (See “File Formats” on p. 3-32.)

⑥ Delivery Options

Sets the send conditions. (See “Delivery Options” on p. 3-34.)

⑦ [Default] button

Resets any modified settings to the default values of the scanner.

! IMPORTANT

If you press [Default] in the Scan/Delivery Options screen opened from a job button, the settings are reset not to the setting values registered to the job button, but to the default values of the scanner.

⑧ [Start] button

Starts scanning.

⑨ [Deskew] button

The scanner detects from the scanned image that the document was fed askew and then straightens the image.

⑩ [Prescan] button

When scanning starts, the first page of the document is scanned and then scanning stops. You can view the image of the first page to check and adjust the brightness and contrast before scanning the entire document.

💡 Hint

- Scanning pauses after the first page of the document is scanned, and the image of the first page is displayed.
- Use the displayed image to confirm and adjust the brightness and contrast. Press [Continue] to confirm the adjusted brightness and contrast for the first image and continue scanning.

⑪ [Back] button

Returns the display to the previous screen.

Scan Settings

The scan settings include basic condition settings (page size, mode, resolution, scanning side, and brightness) and detailed settings for scanning.

Basic Condition Settings

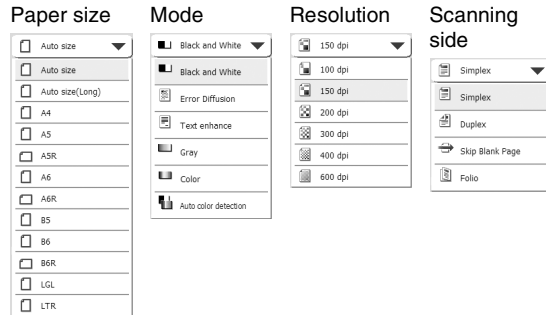

Paper Size

Select the size of the document you want to scan.

Hint

- Select [Auto size] to automatically detect the size of the scanned document.
- When scanning a long document, select [Auto size (Long)].

IMPORTANT

A resolution of [300 dpi] or more cannot be set when [Auto size (Long)] is selected.

Mode

Select the mode for scanning.

IMPORTANT

- The selection of modes is limited depending on the setting set for File Format (see p. 3-32).



- When [Text enhance] is selected, [Bleed-through reduction] in the Detailed Settings screen is grayed out and cannot be selected.
- The [Auto Color Detection] function cannot be used simultaneously with the color drop-out or prescan function.
- The scanning speed may be reduced when the Auto Color Detection function is used.

Resolution

Select the resolution for scanning.

IMPORTANT

- A resolution of [300 dpi] or more cannot be set when [Auto size (Long)] is selected for [Page Size].
- A resolution of [400 dpi] or more cannot be set when [Folio] is selected for [Scanning Side].

Scanning Side

Select the method for scanning the document (Simplex, Duplex, Skip Blank Page).

Hint

- The Skip Blank Page option scans both sides of a document and skips saving any image it determines to be a blank page.
- Selecting Skip Blank Page enables the skip blank page setting in the detailed settings. (See “Skip Blank Page” on p. 3-29.)
- When you select Folio, documents that are folded in half for which duplex scanning is performed can be scanned as a single image.

IMPORTANT

- The scanning speed may be reduced when [Skip Blank Page] is selected.
- A resolution of [400 dpi] or more cannot be set when [Folio] is selected. In addition, [Double feed detection by Ultrasonic] is grayed out and cannot be selected.

Brightness

Adjust the brightness to match the density of the document.



Hint

When you want to scan both sides of a document that has front and back sides of different densities, you can change the settings for the brightness of the front side and back side separately in the detailed settings and then perform scanning.

Detailed Settings

Press the [Detailed settings] button to open the Detailed Settings screen.

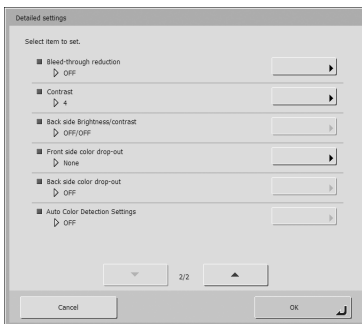
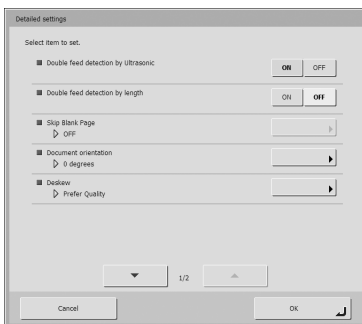

Double feed detection by Ultrasonic (Only Available with the ScanFront 300P)

The scanner uses an ultrasonic sensor to detect when two or more documents are fed together, and stops feeding when a double feed is detected.

! IMPORTANT

- This method is effective when documents overlap by 1.97" (50 mm) or more. It does not function if only a slight portion of the document is overlapping.
- When using the ScanFront 300, the [Double feed detection by Ultrasonic] setting is set to [OFF].
- When [Scanning Side] is set to [Folio], [Double feed detection by Ultrasonic] is grayed out and cannot be selected.

Double feed detection by length

The scanner detects by document length when two or more documents are fed together, and stops feeding when a double feed is detected.

! IMPORTANT

- Using the length of the first page of the document as a reference, the scanner determines a double feed when it detects a document with a length at least 1.38" (35 mm) longer or shorter than the reference length.
- Set [Double feed detection by length] to [OFF] when scanning a document that contains pages of different lengths.

Skip Blank Page

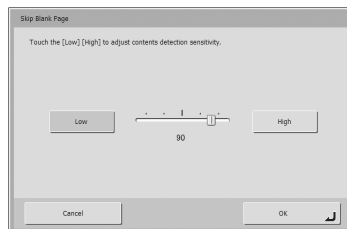

When [Skip Blank Page] is selected in the scanning side settings, this setting is enabled, and you can adjust the sensitivity level for skipping blank pages.

Hint

- The initial value for the Skip Blank Page option is set to “90.”
- As you lower the value from the default setting, pages of the document with text become more likely to be skipped as well.
- As you raise the value from the default setting, pages of the document that are blank become less likely to be skipped.

IMPORTANT

- As you lower the Skip Blank Page value from the default setting, it is then set so that pages of the document with text are more likely to be skipped.
- As you raise the Skip Blank Page value from the default setting, it is then set so that blank pages of the document are less likely to be skipped.

Document orientation

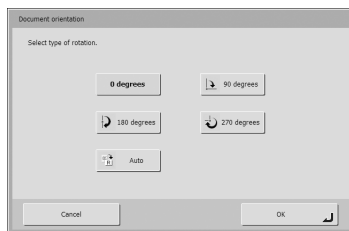

Rotates the scanned image a specified amount.

Hint

If you select [Auto], the orientation of text within the document is detected and the image is rotated so that the orientation of the text is correct.

IMPORTANT

The scanning speed may be reduced when [Auto] is selected.

Deskew

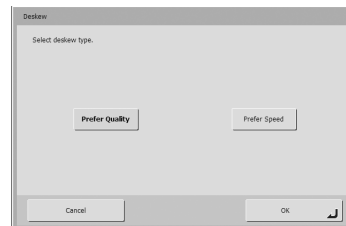

The scanner detects from the scanned image that the document was fed askew and then straightens the image.

• Prefer Quality

Image processing is performed to minimize the loss of quality of an image that has deteriorated as result of deskewing.

• Prefer Speed

The image deteriorates slightly as a result of deskewing.

IMPORTANT

If you select [Prefer Quality], the scanning speed is reduced. If you are scanning a large number of pages, select [Prefer Speed] to prevent a decrease in scanning speed.

Bleed-through reduction

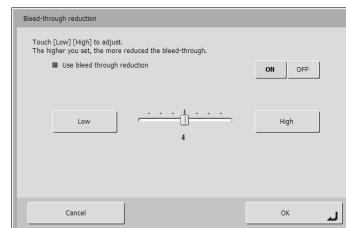

Eliminates bleed-through images, in which images on the reverse side of a scanned document appear on the scanned page, such as when scanning thin documents with text or images on both sides.

IMPORTANT

Bleed-through reduction cannot be set when the [Text enhance] mode is selected.



Hint

When using bleed-through reduction, adjust the bleed-through reduction level to match the type of document.

Contrast

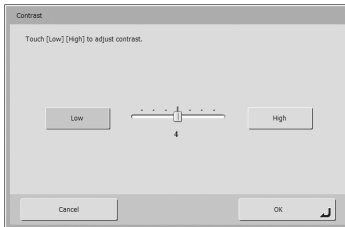

Adjust the contrast for the images to scan.

Back side Brightness/contrast

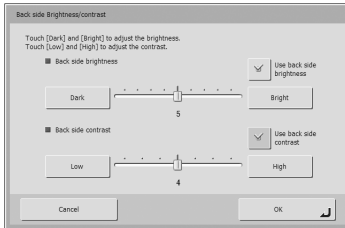

This is enabled when you scan both sides of a document and should be used when the document has front and back sides of different density. Select [Use back side brightness (contrast)] to change the settings for the brightness and contrast of the front and back sides of the document.

Front side (Back side) color drop-out

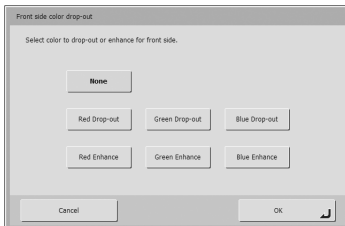

The color drop-out function has a “drop-out” effect that leaves out a specified color (red, blue, or green) while scanning, and a “color enhancement” effect that emphasizes a specified color. You can set each of these effects for the front side and back side.



IMPORTANT

The color drop-out settings are disabled when the scanning mode is set to [Color].

Auto Color Detection Settings

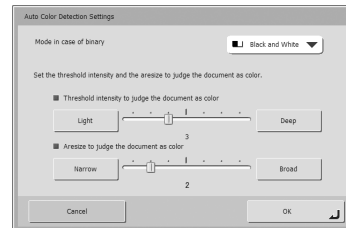

This is enabled when Auto Color Detection is selected, and allows you to configure the following detection settings for determining whether to scan a document in color or black and white.

- **Mode in case of binary**
Specify the scanning mode to use when a black and white document is detected.
- **Threshold intensity to judge the document as color**
Adjust the sensitivity to colors in a document.
- **Aresize to judge the document as color**
Specify the ratio of colored regions in a document.



IMPORTANT

- The [Auto Color Detection] function cannot be used simultaneously with the color drop-out or prescan function.
- The scanning speed may be reduced when the Auto Color Detection function is used.

File Formats

You can select from the three available file formats TIFF, JPEG, and PDF, and the modes available for scanning vary, depending on the file format setting. (See “Mode” on p. 3-28.)

TIFF format

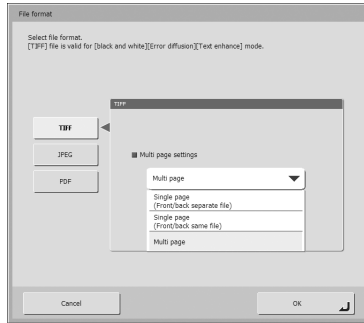

Select [Single page (Front/back separate file)] to save each side of each page as a separate image file, [Single page (Front/back same file)] to save each page as a separate image file, or [Multi page] to save one image file containing multiple pages when scanning multiple pages.

JPEG format

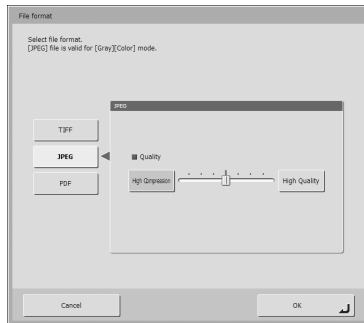

Select the compression rate for JPEG compression.

PDF format

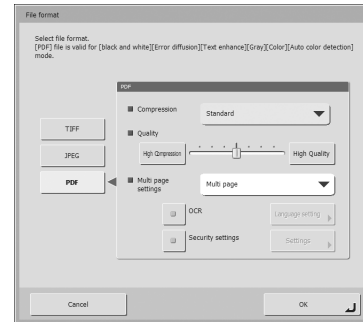

Configure the following settings for saving in PDF format.

- **Compression**
Select the compression method.
- **Quality**
Adjust the quality for the specified compression method.
- **Multi page settings**
Select [Single page (Front/back separate file)] to save each side of each page as a separate image file, [Single page (Front/back same file)] to save each page as a separate image file, or [Multi page] to save one image file containing multiple pages when scanning multiple pages.
- **OCR (Character Recognition)**
If OCR is set to On, character recognition is performed for the text within the scanned document, and the text is embedded in the PDF file as text information.
The [Language setting] button enables you to select the language for character recognition.
- **Encryption (Security)**
If you set encryption to On and then press the [Security settings] button, the Security settings screen appears, and you can configure the security settings for the PDF file. For details, see “Security Settings for PDF Files” on p. 3-33.

❑ Security Settings for PDF Files

Apply security to the PDF file.

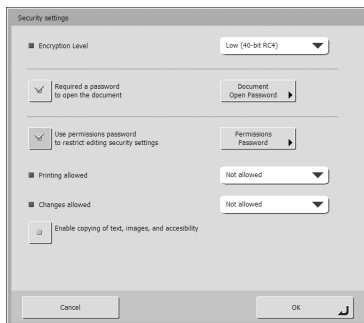

Encryption Level

High (128-bit RC4) and low (40-bit RC4) level settings are available.

! IMPORTANT

Using the High (128-bit RC4) level setting is recommended. The Low (40-bit RC4) level setting provides less security.

Requires a password to open the document

Viewing of the document is restricted by a password.

! IMPORTANT

Take care not to forget the password once it is set. If you forget the password, the document can no longer be opened.

Use permissions password to restrict editing security settings

The following settings are restricted by the permissions password.

- **Printing allowed**
This permits printing of the PDF file with a printer.
- **Changes allowed**
This permits editing of the PDF file; for example, adding and deleting pages.
- **Enable copying of text, images, and accessibility.**
This enables the copying of text information embedded with OCR software and reading of the PDF file with voice software.

! IMPORTANT

- Password protection is recommended when the permissions of the PDF file are restricted.
- You can change the permissions and cancel password protection for a password protected PDF file in an application capable of editing PDF files such as Adobe Acrobat.

□ Delivery Options

Delivery Options

Subject: From ScanFront300

Message:

File name:

Auto file name: yyyyymmdd

20100329104313372

Action when the same named file exists: Display a message

1/2

Cancel OK

E-mail settings (subject, message)

Set the subject and message for sending via e-mail.

File name

Specify a name for the image file to be sent.

Auto file name

The scanner adds 17 digits that indicate the date and time to the file name of the image to be sent.

Ex.) May 14, 2010, 3:40:30 p.m.

yyyymmdd: File name + 20100514154030123

mmddyyyy: File name + 05142010154030123

ddmmyyyy: File name + 14052010154030123

* The last three digits indicate the number of milliseconds.

When custom file name settings are configured in the Web Menu, you can select [Custom] to add the custom file name to the file name of the scanned image (see p. 4-6).

! IMPORTANT

- Make sure you set either [File name] or [Auto file name]. A message appears if you do not enter a file name and then set [Auto file name] to [None].
- If you select [Single page] of TIFF format, or JPEG format, a 4-digit sequential number starting with "0001" is added automatically to the end of file names.
- The following characters cannot be used to set the custom file name:
/ : ? * " < > |

Action when the same named file exists

Set the action to perform when there is already a file of the same name at the destination.

- Display a message
Display a message to confirm overwriting of the file.
- Abort sending
Cancel sending.
- Overwrite the file
Overwrite the file at the destination.

Delivery Options

Send the files immediately after scanning: ON OFF

Confirm addresses before sending: ON OFF

Screen after sending: home screen

Send index file: ON OFF

Index string:

2/2

Cancel OK

Send the files immediately after scanning

Send images without checking them when scanning completes.

Confirm addresses before sending

Confirm the addresses before sending images when scanning completes.

Screen after sending

Select the screen to display after sending images.

- **Home screen (Job Button screen)**

Redisplay the Home screen (Job Button screen) after sending images.

IMPORTANT

- The [Screen after Login] setting that is set via the Web menu by the user applies to the Home screen (Job Button screen) setting.
- The Job Button screen is displayed for a user for which use of the Home screen is restricted by the ScanFront administrator.

- **Logout**

The user is logged out after sending images.

- **Select screen after sending**

A dialog box for selecting the screen after sending images is displayed.

Hint

When no user is registered, the Logout option does not appear.

Send index file

Specify whether to send index files (metadata) with images.

When sending index files, enter an index string.

Index files are created according to the settings configured in the Web Menu (see p. 4-6).

IMPORTANT

The following characters cannot be used in strings contained in the index file:

& " ' < >

Chapter 4 Web Menu (User Mode)

1. Web Menu Overview.....	4-2
2. Logging In to the Web Menu.....	4-3
3. User Settings	4-4
User Settings.....	4-5
4. Address Book Settings.....	4-8
Registering New Addresses.....	4-10
Copying Addresses	4-13
Exporting and Importing Address Books.....	4-13
5. Job Button Settings.....	4-15
Registering New Job Buttons.....	4-17
Scan Settings Overview	4-18
Copying Job Buttons	4-22
Editing Jobs.....	4-23
Exporting and Importing Job Buttons	4-23

1. Web Menu Overview

The Web Menu function enables you to access and configure the scanner from the Web browser of a remote computer. From the Web Menu, you can register address books and job buttons.

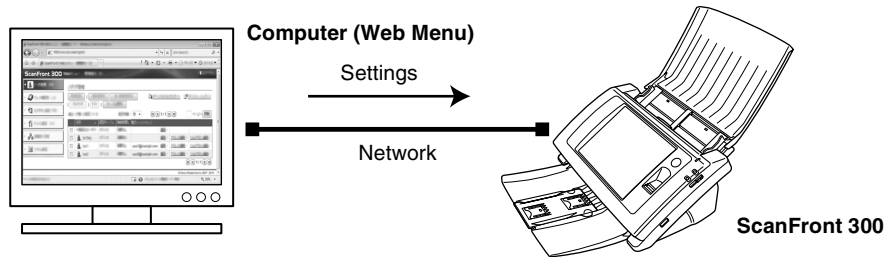

! IMPORTANT

- For a Web browser, use Microsoft Internet Explorer 6.0 or later or Firefox 3.5 or later.
- In some cases, settings cannot be changed from the Web Menu when the ScanFront administrator or another user is logged in to the scanner.
- Use the device name or IP address assigned to the scanner as the URL for logging in to the Web Menu. (See p. 4-3.)
- When you open the Web Menu using Internet Explorer 7 or later, an SSL-certificate warning will appear. However, you can proceed and open the Web Menu safely.

Web Menu (User Mode)

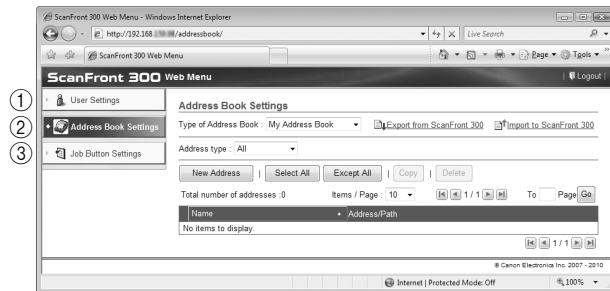

- ① **User Settings** (See “User Settings” on p. 4-5)
Use to change the user settings.
- ② **Address Book Settings** (See “Address Book Settings” on p. 4-8)
Use to register and manage entries in the Shared Address Book available to all users, and the My Address Book provided for each user.
- ③ **Job Button Settings** (See “Job Button Settings” on p. 4-15)
Use to register and manage the Shared Job Button available to all users, and the My Job Button provided for each user.

2. Logging In to the Web Menu

You can log in to the Web Menu using the following procedure.

Hint

Use the device name or the IP address assigned to the scanner as the URL for accessing the Web Menu. Contact the ScanFront administrator for the device name and the IP address.

1. Turn the scanner ON.
2. Confirm the IP address with the administrator.
3. Launch the Web browser on the computer.
4. Enter the device name or the IP address as the URL to open the Web Menu.

Ex.) <http://scanfront300> when the device name is ScanFront300, and <http://172.19.xxx.xxx> for the IP address.

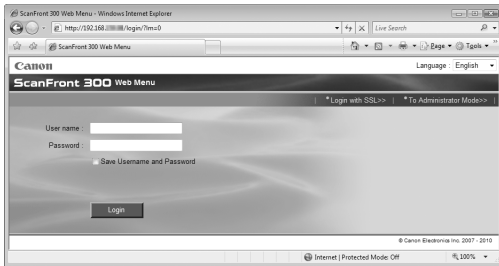

Hint

If the Web Menu is set to Administrator Mode, click [To User Mode].

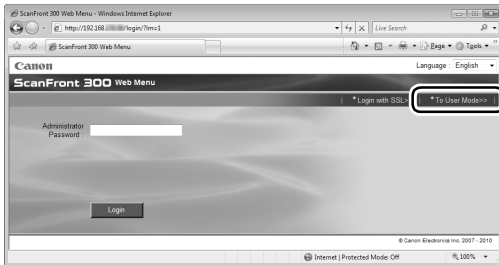

IMPORTANT

If [Authentication Method] appears above [User name] on the login screen, users can log in from an account registered on a domain server (Server Authentication), instead of logging in from an account registered on the scanner (Device Authentication). For details, consult the ScanFront administrator.

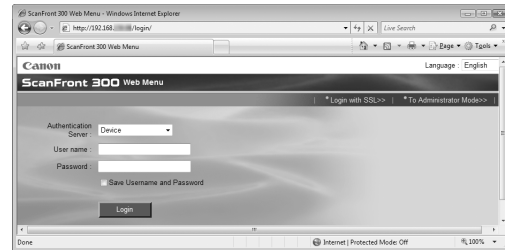

5. Enter a user name and password to log in to the Web Menu.

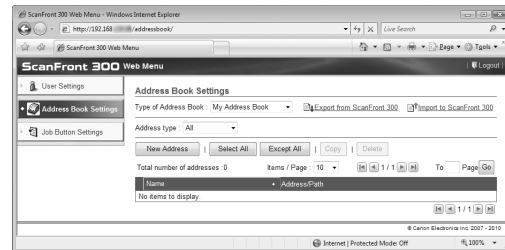

IMPORTANT

User names and passwords are case-sensitive. Make sure to enter them correctly.

3. User Settings

From the User Settings screen, you can change the information of a user logged in by Device Authentication.

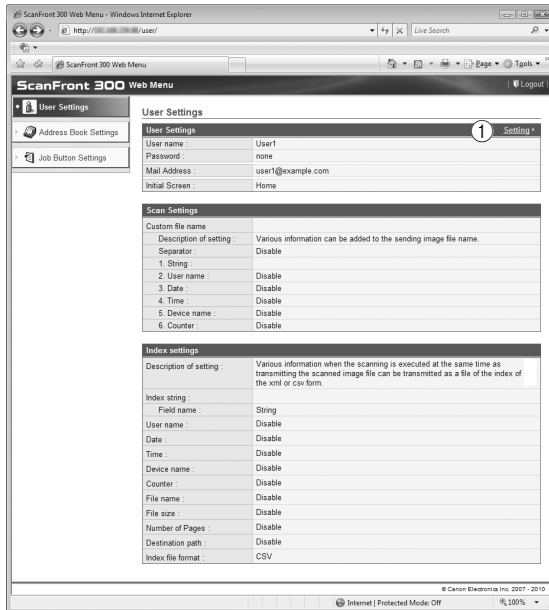

- ① Setting (See “User Settings” on p. 4-4)
Allows you to edit a user’s settings.

❑ User Settings

Click [Setting] to edit the user information.

User Settings

User Settings > Edit

User Settings	
Authentication Server :	Device
User name :	User1
Change password :	<input type="checkbox"/> Change Password
Password :	<input type="password"/>
Password(confirmation) :	<input type="password"/>
Mail Address :	user1@example.com
Screen after Login :	<input checked="" type="radio"/> Home <input type="radio"/> Job Button screen

- **User name**
Enter a new user name.
- **Change Password**
Select the [Change Password] check box, and then enter the new password and confirmation password.
- **Mail Address (Not Changeable)**
To change the e-mail address, contact the ScanFront administrator.
- **SMTP/POP Before SMTP Authentication**
Appears when [Auth Method] is configured to any setting other than [SMTP] by the administrator in the mail server settings. Enter the [User name] and [Password] that will be used for mail server authentication here.

! IMPORTANT

- When entering a [Password], select the [Change Password] check box before entry.
- [Change Password] updates the password information saved on the scanner, but does not alter the password registered on the server.
- For a user logged in by Server Authentication, you can only select a setting for [Screen after Login].
- E-mail address may not be registered for a user logged in by Server Authentication. For details on e-mail address settings, consult the ScanFront administrator.
- **Screen after Login**
Select the Home screen or the Job Button screen as the first screen to appear after the user logs in.

Home Screen

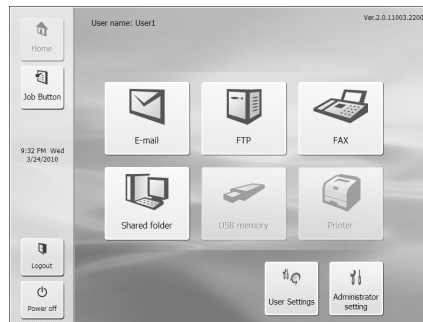

Job Button Screen

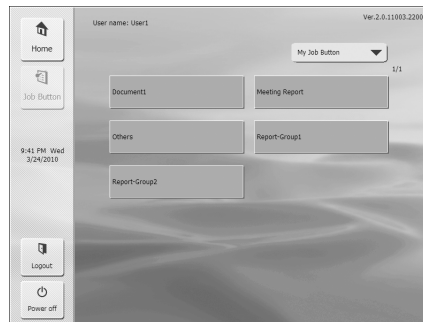

! IMPORTANT

- The setting for the startup screen after login also affects which screen appears after a scanned image is sent. (See “Delivery Options” on p. 4-17.)
- If the ScanFront administrator has restricted use of the Home screen, only [Job Button screen] is available for the [Screen after Login] setting. For details, consult the ScanFront administrator.

Custom File Name Settings

Specify the method in which file names used for saving scanned images are created. When you select to use custom file names during a scanning procedure, the image files will be saved under file names that are determined by the settings configured here. Components of the custom file name will be included in the order that they appear on this screen.

Custom file name Settings	
Custom file name	
Description of setting :	Various information can be added to the sending image file name.
Separator :	<input type="checkbox"/> Enable +(Hyphen) ▾
1. String :	<input type="text"/>
2. User name :	<input type="checkbox"/> Enable
3. Date :	<input type="checkbox"/> Enable yyymmdd ▾
4. Time :	<input type="checkbox"/> Enable hhmmss ▾
5. Device name :	<input type="checkbox"/> Enable
6. Counter :	<input type="checkbox"/> Enable (Counter settings become effective only when using a single page setting.)
Start number :	<input type="text" value="0"/>
Number of digits :	<input type="text" value="0"/>

! IMPORTANT

The following characters cannot be used to set the custom file name:

/: ? * " < > |

• Separator

Select the [Enable] check box to include a separator between character strings in the file name, and select a character to use as the separator in the list box.

• String

Specify a string to include in the file name.

• User name

Select the [Enable] check box to include the user name in the file name.

• Date

Select the [Enable] check box to include the date in the file name, and select a format for the date in the list box.

• Time

Select the [Enable] check box to include the time in the file name, and select a format for the time in the list box.

• Device name

Select the [Enable] check box to include the device name in the file name.

• Counter/Start number/Number of digits

Select the [Enable] check box to include a counter in the file name. When this is enabled, you can specify the starting value and number of digits used for the counter.

Index Settings

Specify the content of index files (metadata) that are attached to scanned image files. Components of the index file will be included in the order that they appear on this screen.

Index settings	
Description of setting :	Various information when the scanning is executed at the same time as transmitting the scanned image file can be transmitted as a file of the index of the xml or csv form.
Index string :	<input type="text"/>
Field name :	<input type="text"/>
User name :	<input type="checkbox"/> Enable
Field name :	<input type="text"/>
Date :	<input type="checkbox"/> Enable
Format :	yyymmdd ▾
Field name :	<input type="text"/>
Time :	<input type="checkbox"/> Enable
Format :	hhmmss ▾
Field name :	<input type="text"/>
Device name :	<input type="checkbox"/> Enable
Field name :	<input type="text"/>
Counter :	<input type="checkbox"/> Enable
Start number :	<input type="text" value="0"/>
Number of digits :	<input type="text" value="0"/>
Field name :	<input type="text"/>
File name :	<input type="checkbox"/> Enable
Field name :	<input type="text"/>
File size :	<input type="checkbox"/> Enable
Field name :	<input type="text"/>
Number of Pages :	<input type="checkbox"/> Enable
Field name :	<input type="text"/>
Destination path :	<input type="checkbox"/> Enable
Field name :	<input type="text"/>
Index file format :	<input type="radio"/> XML <input checked="" type="radio"/> CSV

! IMPORTANT

The following characters cannot be used in strings contained in the index file:

& " ' < >

- **Index string/Field name**
Enter a string for the index. You can change the default field name (“String”) as necessary.
- **User name**
Select the [Enable] check box to include the user name in the index file. You can change the default field name (“User”) as necessary.
- **Date**
Select the [Enable] check box to include the date in the index file, and select a format for the date in the [Format] list box. You can change the default field name (“Date”) as necessary.
- **Time**
Select the [Enable] check box to include the time in the index file, and select a format for the time in the [Format] list box. You can change the default field name (“Time”) as necessary.
- **Device name**
Select the [Enable] check box to include the device name in the index file. You can change the default field name (“Device”) as necessary.
- **Counter/Start number/Number of digits**
Select the [Enable] check box to include a counter in the index file. When this is enabled, you can specify the starting value and number of digits used for the counter. You can change the default field name (“Counter”) as necessary.
- **File name**
Select the [Enable] check box to include the file name in the index file. You can change the default field name (“FileName”) as necessary.
- **File size**
Select the [Enable] check box to include the file size in the index file. You can change the default field name (“FileSize”) as necessary.

- **Number of Pages**
Select the [Enable] check box to include the number of pages that are in the scanned image in the index file. You can change the default field name (“PageNumber”) as necessary.
- **Destination path**
Select the [Enable] check box to include the destination path in the index file. You can change the default field name (“Folder”) as necessary.
- **Index file format**
Specify a file format for the index files.

[OK] button

Updates the user information with the changed settings.

4. Address Book Settings

From the Address Book Settings screen, you can register entries in the Shared Address Book, which is available to all users, and the My Address Book, which is provided for each user.

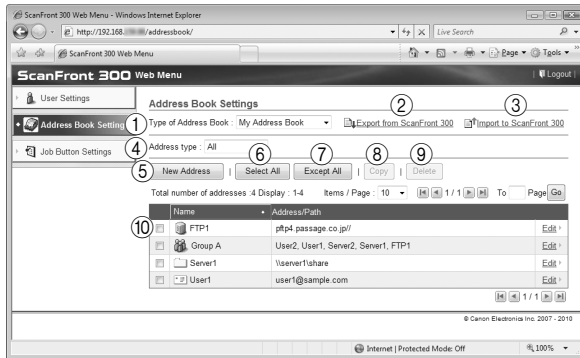

① Type of Address Book

Selects the address book (Shared Address Book or My Address Book) to edit.

The LDAP Address Book is also selectable if the address book server settings are enabled and permission to use the LDAP address book has been granted to the user. The address type is set to [E-mail] when the LDAP Address Book is selected.

② Export from ScanFront 300

Exports the address book data as a file in CSV format. (See “Exporting and Importing Address Books” on p. 4-13.)

③ Import to ScanFront 300

Imports a previously exported address book data file. (See “Exporting and Importing Address Books” on p. 4-13.)

④ Address type

Selects the type of addresses (E-mail, FTP Server, Shared folder, Group, or All) to display.

⑤ [New Address] button

Registers a new address book entry. (See “Registering New Addresses” on p. 4-10.)

⑥ [Select All] button

Selects all of the displayed addresses.

⑦ [Except All] button

Deselects all of the displayed addresses.

⑧ [Copy] button

Copies the selected address. Only enabled when an address is selected. (See “Copying Addresses” on p. 4-13.)

⑨ [Delete] button

Deletes the selected address. Only enabled when an address is selected.

⑩ Address List

Displays the registered addresses.

- **Check box:** Select this check box to select an address.

- **Address type (icon)**

- : FTP

- : Shared folder

- : E-mail

- : Fax

- : Group

- **Edit:** Click to edit an address.

! IMPORTANT

If the ScanFront administrator has restricted editing of the address books, the following Address Book settings apply. For details, consult the ScanFront administrator.

- If editing is restricted for only one address book (either the My Address Book or the Shared Address Book), users can only copy addresses from the restricted address book and paste them into the unrestricted address book.

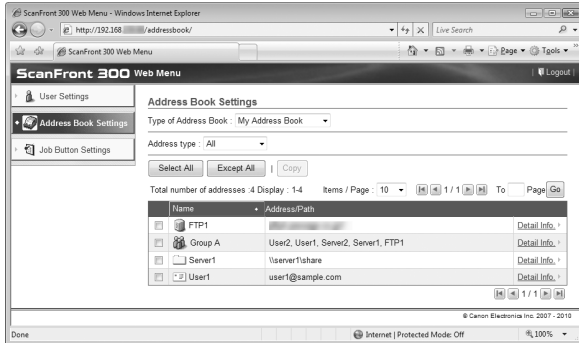

- If editing is restricted for both the My Address Book and the Shared Address Book, users can only view detailed address information.

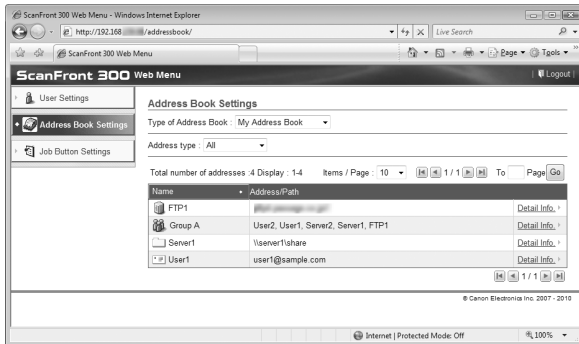

❑ Registering New Addresses

Select the type of address book (Shared Address Book or My Address Book), and click [New Address] to register a new address.



Hint

- The number of addresses that can be registered to the Shared Address Book (My Address Book) is up to 1000 in combination with the total number of addresses included in the Shared Job Button (My Job Button).
- For the number mentioned above, the count for a group is the number of addresses registered to the group (maximum of 99 addresses) plus the group name, so a group with 99 addresses registered to it is counted as having 100 addresses.
- The available settings vary, depending on the type of address (E-mail, FTP Server, Shared folder, Fax, or Group).

Address type: E-mail

This option registers an e-mail address.

Address Book Settings > My Address Book > New Address

Address type : E-mail

Address Book Settings - E-mail

Name :

E-mail Address :

OK Cancel

Name

Enter the name to display on the scanner.

E-mail Address

Enter the destination e-mail address.

[OK] button

Registers a new e-mail address with the specified parameters.

Address type: FTP Server

This option registers a network FTP server.



IMPORTANT

FTP servers that require firewall settings cannot be registered.

Address Book Settings > My Address Book > New Address

Address type : FTP Server

Address Book Settings - FTP Server

Name :

FTP server :

Folder path : Browse...

Port number : 21

User name :

Password :

Save Password : Save Password

Passive Mode : Passive Mode

OK Cancel

Name

Enter the name to display on the scanner.

FTP server

Enter the IP address or host name of the FTP server.

Folder path

To specify a subfolder on the FTP server, enter the path to the subfolder.



Hint

If you are unsure of the subfolder's path, use the following procedure to specify the subfolder:

1. After entering the [FTP server], [User name], and [Password], click [Browse] and log in to the FTP server.
2. In the folder that appears, specify any subfolder and click [OK].

User name/Password

Enter the user name and password required to log in to the FTP server.



IMPORTANT

Make sure to enter the user name and password of an account with the authority to write data to the FTP server.

Port number

Enter the port number. The standard port number is 21.

Save Password

Saves the entered password.

Passive Mode

Uses passive mode to send transmissions to the FTP server.

! IMPORTANT

Use passive mode when normal communication with the FTP server cannot be established. However, be aware that communication may not be possible if the network is not functioning properly.

[OK] button

Registers a new FTP server with the specified parameters.

Address type: Shared folder

This option registers a folder shared publicly on the network.

Address Book Settings > My Address Book > New Address

Address type :	Shared folder ▼
Address Book Settings - Shared folder	
Name :	<input type="text"/>
Computer Name (Host Name) :	<input type="text"/>
Folder path :	<input type="text"/> <input type="button" value="Browse"/>
<small>In order to display the list of all computers in a certain domain, please enter "User name" and "Password" to log in that domain, then click the "Browse" button.</small>	
User name :	<input type="text"/>
Password :	<input type="password"/>
Domain / Workgroup :	<input type="text"/>
Save Password :	<input checked="" type="checkbox"/> Save Password

Name

Enter the name to display on the scanner.

Computer Name (Host Name)

Enter the name of the computer containing the publicly shared folder. When the ScanFront Service is running, you can enter the IP address instead of a host name.

Folder path

Enter the path to the subfolder that you want to register as the name of the shared folder.

[Browse] button

Shows a list of computers connected to the network for you to specify a shared folder.

💡 Hint

You can display the shared folders using the following procedure.

1. After entering the computer name, user name, password, and domain/workgroup, click [Browse]. Access the computer containing the publicly shared folder. Sub-folders on computers running Windows 7 or Windows Server 2008 R2 cannot be browsed by clicking the [Browse] button. In such cases, enter the computer name and path up until the top-most folder of that computer in [Folder path], and then click [Browse].
2. Specify any subfolder from the displayed computer and click [OK].

! IMPORTANT

- If you click [Browse] without entering the user account information, only computers and workgroups within the same network address will display.
- When displaying workgroups that are not part of a domain, you cannot display computers or workgroups with different network addresses.
- Not all workgroups and computers in the network can be displayed immediately after the ScanFront is started. If some workgroups and computers are not displayed, wait a few minutes and then press [Browse].
- A new folder cannot be created in a specified folder via the Web Menu. If you want to create a new folder, use the computer set as the FTP server or the address editing functions of the ScanFront to create a folder beforehand.

User name/Password

Enter the user name and password of an account with the authority to write data to the shared folder.

Domain/Workgroup

If the computer containing the shared folder is part of a domain, enter the domain name.

! IMPORTANT

- If the computer containing the publicly shared folder is part of a domain, enter the user name and password registered with the domain, and the domain name.
- If the computer containing the publicly shared folder is not part of a domain, there is no need to enter a [Domain/Workgroup].

Save Password

Select this check box to save the password to the address.

! IMPORTANT

If you do not save the password, password entry will be required each time you send.

[OK] button

Registers a new shared folder with the specified parameters.

Address type: Fax

This option registers a fax destination.

Address Book Settings > My Address Book > New Address

Address type : Fax

Address Book Settings - Fax

Name : _____

Fax number : _____

OK Cancel

Fax number

Enter the fax number of the destination.

[OK] button

Registers a new fax destination with the specified parameters.

Address type: Group

This option registers several registered addresses together as a group.



Hint

Different types of address, such as e-mail addresses and shared folders, can be registered as a group, and up to 99 addresses can be registered to 1 group.

Address Book Settings > My Address Book > New Address

Address type : Group

Address Book Settings - Group

Name : _____

Address Settings Add from Address Book*

Total number of addresses: 0 Items / Page: 10 To Page: Go

Name	Address/Path
No items to display.	

OK Cancel

Name

Enter the name to display on the scanner.

Add from Address Book

Allows you to select an address from an address book, add it to the group, and display it in the list.

[OK] button

Registers a new group with the specified parameters.

❑ Copying Addresses

You can copy an address and register it as a new address. You can also copy an address from one address book to another.

As an example, this section describes how to copy from the Shared Address Book to the My Address Book.

Hint

Use this function when you want to copy an address between the Shared Address Book and My Address Book or copy an address and register it as a different address in the same address book after changing some of the settings.

1. Select Shared Address Book for the [Type of Address Book].
2. Add a checkmark to the check box of the address you want to copy and then click [Copy].

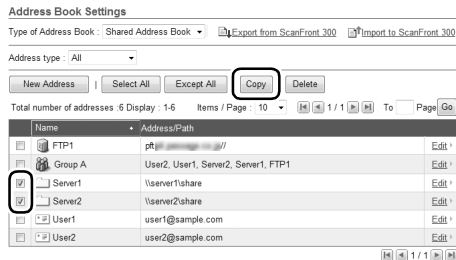

3. Select My Address Book for the copy destination, and click [OK].

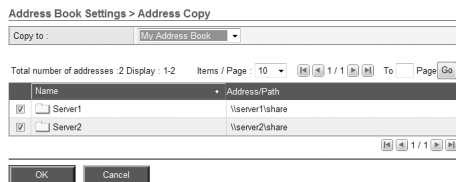

4. Confirm the copied address.

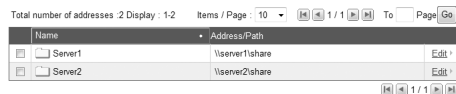

❑ Exporting and Importing Address Books

You can back up your address books as files in CSV format, and import the backed up address book data to another ScanFront unit.

Hint

If you have multiple ScanFront units, you can use the same address books on all of them by importing the address book settings file registered on one ScanFront unit to the other units.

Exporting from the Scanner

You can save the address book data to a specified folder.

1. Click [Export from ScanFront 300].



2. Click [Save], specify a save location, and save the address book data.

Hint

- You can open the saved CSV file with software that supports CSV files such as spread sheet software in order to check the structure of the file.
- You can match the structure of a CSV file created in another mailer to that of a CSV file saved on the ScanFront, and then import the address book of the other mailer and use it on the ScanFront.

Importing to the Scanner

You can import previously exported address book data to the scanner.

1. Click [Import to ScanFront 300].

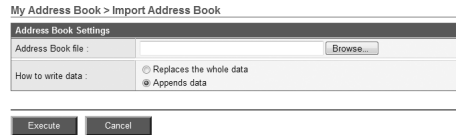

2. Click [Browse] and specify a previously exported address book settings file.

3. Select a processing method for importing the address book settings file.

- **Replaces the whole data:** Deletes all currently registered address book entries and overwrites them with the imported address book data.
- **Appends data:** Adds the imported address book data to the currently registered address book.

4. Click [Execute].

Confirm the message that appears, and click [OK] to import the data.

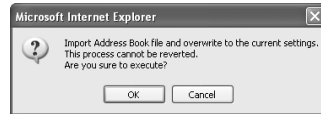

Hint

When importing is completed, the following message appears. Click [OK] to return to Address Book Settings and confirm the imported address data.



5. Job Button Settings

From the Job Button Settings screen, you can register the Shared Job Button, which is available to all users, and the My Job Button, which is provided for each user.

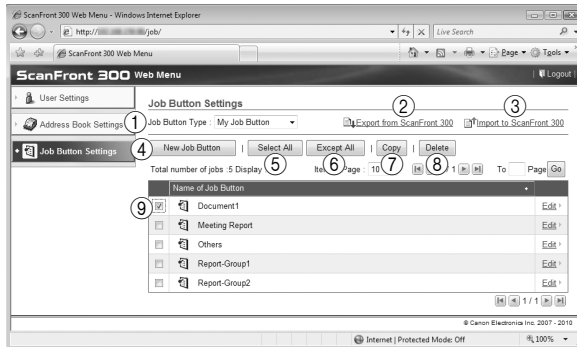

- ① **Job Button Type**
Select the job button (Shared Job Button or My Job Button) that you want to edit.
- ② **Export from ScanFront 300**
Exports the job button data as a file in DAT format. (See “Exporting and Importing Job Buttons” on p. 4-23.)
- ③ **Import to ScanFront 300**
Imports a previously exported job button data file. (See “Exporting and Importing Job Buttons” on p. 4-23.)
- ④ **[New Job Button] button**
Registers a new job button. (See “Registering New Job Buttons” on p. 4-17.)
- ⑤ **[Select All] button**
Selects all of the displayed job buttons.
- ⑥ **[Except All] button**
Deselects all of the displayed job buttons.
- ⑦ **[Copy] button**
Copies the selected job button. Only enabled when a job button is selected. (See “Copying Job Buttons” on p. 4-22.)
- ⑧ **[Delete] button**
Deletes the selected job button. Only enabled when a job button is selected.
- ⑨ **Job Button List**
Displays the registered job buttons.
 - **Check box:** Select this check box to select a job button.
 - **Edit:** Click to edit a job button.

! IMPORTANT

If the ScanFront administrator has restricted editing of the job buttons, the following Job Button settings apply. For details, consult the ScanFront administrator.

- If editing is restricted for only one set of job buttons (either the My Job Button or the Shared Job Button), users can copy job buttons from the restricted set of job buttons and paste them into the unrestricted set.

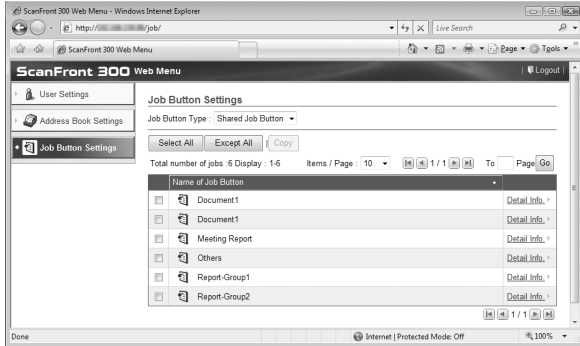

- If editing is restricted for both the My Job Button and the Shared Job Button, users can only view detailed job button information.

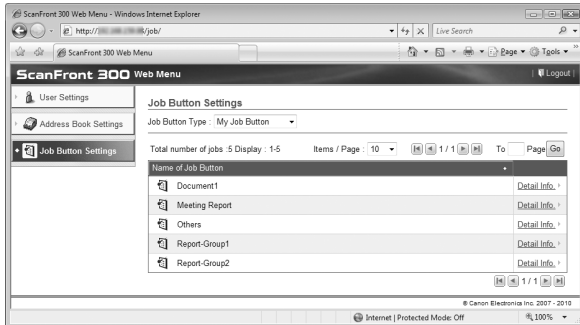

❑ Registering New Job Buttons

Click [New Job Button] to register a new job button.

Job Button Settings

Job Button > Shared Job Button > New Job Button

Job Button Settings	
Name of Job Button	<input type="text"/>
Color of Job Button	<input checked="" type="radio"/> Blue <input type="radio"/> Yellow <input type="radio"/> Pink <input type="radio"/> Red <input type="radio"/> Orange <input type="radio"/> Purple <input type="radio"/> Skyblue
When you select this Job Button	Display Scan Setting Screen ▾

Name of Job Button

Enter the job button name to display on the touch panel.



Hint

- Job buttons are sorted and displayed by job button name. If you want to set to display job buttons in a particular order, insert sequential letters or numbers before the name when registering each job button. Ex.) 01_xxxx
- If you enter a job button name that is two lines long, the job button display will be two lines long.

Color of Job Button

Specify a color for the job button.

When you select this Job Button

- Display Scan Setting Screen
Displays the Scan Setting screen when the job button is pressed.
- Skip Scan Setting Screen
Starts scanning without displaying the Scan Setting screen when the job button is pressed.



IMPORTANT

If you select [Skip Scan Setting Screen], scanning starts as soon as the job button is pressed, whether a document is inserted or not.

Address

Click [Add from Address Book], open the Address page, and select the address to send to.



IMPORTANT

- You can register up to 100 addresses to a job button.
- For the number mentioned above, the count for a group is the number of addresses registered to the group (maximum of 99 addresses) plus the group name, so a group with 99 addresses registered to it is counted as having 100 addresses.

Scan Settings/Detailed settings

For details on Scan Settings/Detailed settings, see “Scan Settings Overview” on p. 4-18.

E-mail settings

Subject

Enter a subject for the e-mail message.

Message

Enter the text of the e-mail message.

Delivery Options

Action when the same named file exists

Select the action to take when a file of the same name exists at the destination.

- **Display a message**
Displays a message confirming that the file will be overwritten.
- **Abort sending**
Cancels sending.
- **Overwrite the file**
Overwrites the identically named file without displaying a confirmation message.

Send the files immediately after scanning

- **ON**
Starts sending when scanning completes.
- **OFF**
Starts sending after you confirm the scanned image when scanning completes.

Confirm addresses before sending

- **ON**
Displays the Address Confirmation screen, and then starts sending after you confirm the address.
- **OFF**
Sends the image without confirming the address.

Screen after sending

Select the screen to display after an image is sent.

- **Initial Screen**
Returns to the startup screen set for [Screen after Login] in the User Settings.
- **Logout**
Logs out after the images are sent.
- **Select screen after sending**
Displays a message dialog for selecting from the above actions after the images are sent.

Index Settings

Specify whether to attach metadata (index files) to scanned images.

Index settings	
Description of setting :	Various information when the scanning is executed at the same time as transmitting the scanned image file can be transmitted as a file of the index of the xrd or csv form.
Send index file :	<input type="radio"/> ON <input checked="" type="radio"/> OFF

OK Cancel Default

Scan Settings Overview

The scan settings include basic and detailed settings for scanning parameters and individual settings by file format.

Scan Settings

Scan Settings	
Page Size :	Auto size ▾
Mode :	Black and White ▾
Resolution(dpi) :	150 ▾
Scanning Side :	Simplex ▾
Skip Blank Page Contents detection sensitivity :	<input type="text" value="50"/> (0 - 100) 0 : Low 100 : High
Prescan :	<input type="radio"/> ON <input checked="" type="radio"/> OFF
File name :	<input type="text"/>
When you select this Job Button :	Skip the file name entry screen ▾
Add Date to File name :	mmddyyyy ▾
File format :	<input checked="" type="radio"/> TIFF <input type="radio"/> JPEG <input type="radio"/> PDF
Multi page settings :	Multi page ▾

Page Size

Select the size of the document to scan from the list.



Hint

- The [Auto size] option automatically detects the size of the scanned document during scanning.
- When scanning a long document, select [Auto size (Long)]

! IMPORTANT

A resolution of [300 dpi] or more cannot be set when [Auto size (Long)] is selected.

Mode

Select the scanning mode (Black and White, Error Diffusion, Text enhance, Gray, Color, Auto Color Detection).

When [Auto Color Detection] is selected, the scanner automatically detects whether the document is color or black and white. When this option is selected, you can also configure the following settings.

Mode :	Auto color detection ▾
Auto Color Detection	
Settings :	
Mode in case of binary :	Black and White ▾
Threshold intensity to judge the document as color :	3 ▾
Aresize to judge the document as color :	2 ▾
Resolution(dpi) :	150 ▾
Scanning Side :	Simplex ▾
Skip Blank Page Contents detection sensitivity :	90 (0 - 100) 0 Low 100 High
Prescan :	<input type="radio"/> ON <input checked="" type="radio"/> OFF

- **Mode in case of binary**
Specify the scanning mode to use when a black and white document is detected.
- **Threshold intensity to judge the document as color**
Adjust the sensitivity to colors in a document.
- **Aresize to judge the document as color**
Specify the ratio of colored regions in a document.

! IMPORTANT

- The [Auto Color Detection] function cannot be used simultaneously with the color drop-out or prescan function.
- Depending on the selected mode, the file formats available for saving may be limited. A warning message appears when an unavailable combination is selected.

	TIFF	JPEG	PDF
Black and White	Yes	No	Yes
Error Diffusion	Yes	No	Yes
Text enhance	Yes	No	Yes
Gray	No	Yes	Yes
Color	No	Yes	Yes
Auto Color Detection	No	No	Yes

- When [Text enhance] is selected, [Bleed-through reduction] cannot be selected.

Resolution (dpi)

Select the scanning resolution (100, 150, 200, 300, 400, or 600 dpi).

Scanning Side

Select the method for scanning the document (Simplex, Duplex, Skip blank page, Folio).



Hint

- The Skip Blank Page option scans both sides of a document and skips saving any image it determines to be a blank page.
- You can adjust the sensitivity of the Skip Blank Page option under [Contents detection sensitivity].
- The initial value for the Skip Blank Page option is set to "90." As you lower the value from the default setting, pages of the document with text become more likely to be skipped as well. As you raise the value from the default setting, pages of the document that are blank become less likely to be skipped.



! IMPORTANT

- The scanning speed may be reduced when [Skip Blank Page] is selected.
- A resolution of [400 dpi] or more cannot be set when [Folio] is selected. In addition, [Double feed detection by Ultrasonic] cannot be selected.

Prescan

Enables you to preview an image of the first page of the document before scanning the entire document.



Hint

- Scanning pauses after the first page of the document is scanned, and the image of the first page is displayed.
- Use the displayed image to confirm and adjust the brightness and contrast. Press [Continue] to confirm the adjusted brightness and contrast for the first image and continue scanning.

File name

Specify a name for the image file to be sent.

Add Date to File name

The scanner adds 17 digits that indicate the date and time to the file name of the image to be sent.

Ex.) May 14, 2010, 3:40:30 p.m.

yyyymmdd: File name + 20100514154030123

mmdyyy: File name + 05142010154030123

ddmmyyyy: File name + 14052010154030123

* The last three digits indicate the number of milliseconds.

You can select [Custom] to configure additional file name settings. The additional settings are identical to those in "Custom File Name Settings" on p. 4-6.

When you select this Job Button

Specify whether the file name entry screen appears when you start scanning using the job button.

File format

Select a file format for the image file, and configure the corresponding settings.

TIFF: Multi page settings

File format :	<input checked="" type="radio"/> TIFF <input type="radio"/> JPEG <input type="radio"/> PDF
Multi page settings :	Multi page

Select [Single page (Front/back separate file)] to save each side of each page as a separate image file, [Single page (Front/back same file)] to save each page as a separate image file, or [Multi page] to save one image file containing multiple pages when scanning multiple pages.

JPEG: Compression

File format :	<input type="radio"/> TIFF <input checked="" type="radio"/> JPEG <input type="radio"/> PDF
Compression :	4(normal)
Detailed settings	1(High Compression)
Brightness(Front) :	4(normal)
Brightness(Back) :	5
Contrast(Front) :	6 front
	7(High Quality)

Select a compression ratio for images saved in JPEG format.

PDF:

Configure the settings for compression ratio, multi page, OCR (optical character recognition), and security.

File format :	<input type="radio"/> TIFF <input type="radio"/> JPEG <input checked="" type="radio"/> PDF
Compression Method :	<input checked="" type="radio"/> Standard <input type="radio"/> High Compression
Compression :	4(normal)
Multi page settings :	Multi page
OCR :	<input checked="" type="radio"/> ON <input type="radio"/> OFF
OCR language setting :	English
Encryption :	<input checked="" type="radio"/> ON <input type="radio"/> OFF
Encryption Level :	<input checked="" type="radio"/> Low (40-bit RC4) <input type="radio"/> High(128-bit RC4)
Protect Document :	<input checked="" type="checkbox"/> Required a password to open the document
Document Open Password :	<input type="text"/> (confirmation)
Protect Permission :	<input checked="" type="checkbox"/> Use permissions password to restrict editing security settings
Permissions Password :	<input type="text"/> (confirmation)
Printing allowed :	<input type="radio"/> Allowed <input checked="" type="radio"/> Not allowed
Changes allowed :	<input type="radio"/> Allowed <input checked="" type="radio"/> Not allowed
Enable copying of text, images, and accessibility :	<input type="radio"/> ON <input checked="" type="radio"/> OFF

Compression Method

Specify a compression level by selecting [Standard] or [High Compression] as the compression method.

OCR (Optical Character Recognition)

When OCR is set to [ON], the scanner performs character recognition on textual portions of the document, and embeds the detected characters as editable text information in the PDF file.

Hint

When you set OCR to [ON], make sure to select the OCR language that matches the document text.

Encryption

Apply security to the PDF file.

IMPORTANT

Using the High (128-bit RC4) level setting is recommended. The Low (40-bit RC4) level setting provides less security.

Protect Document

The ability to view the document is protected by a password.

IMPORTANT

Take care not to forget the password once it is set. If you forget the password, the document can no longer be opened.

Protect Permission

Permissions for printing and editing the PDF file are protected by a password.

Printing allowed

Enables the PDF file to be printed from a printer.

Changes allowed

Enables editing of the PDF file, such as adding or deleting pages.

Enable copying of text, images, and accessibility

Enables text information embedded by OCR to be copied and the PDF file to be read aloud by text-to-speech software.

! IMPORTANT

- Protecting PDF file permissions is recommended when the permissions have been restricted.
- You can change the permissions and cancel password protection for a password protected PDF file in an application capable of editing PDF files such as Adobe Acrobat.

Detailed settings

Detailed settings	
Brightness(Front) :	5(normal) ▾
Brightness(Back) :	5(normal) ▾ <input checked="" type="checkbox"/> Same as front
Contrast(Front) :	4(normal) ▾
Contrast(Back) :	4(normal) ▾ <input checked="" type="checkbox"/> Same as front
Double feed detection by Ultrasonic :	<input type="radio"/> ON <input checked="" type="radio"/> OFF
Double feed detection by length :	<input type="radio"/> ON <input checked="" type="radio"/> OFF
Document orientation :	<input checked="" type="radio"/> 0 <input type="radio"/> 90 <input type="radio"/> 180 <input type="radio"/> 270 <input type="radio"/> Auto
Deskew :	<input checked="" type="radio"/> Prefer Quality <input type="radio"/> Prefer Speed <input type="radio"/> OFF
Bleed-through reduction :	<input type="radio"/> ON <input checked="" type="radio"/> OFF
Bleed Through Reduction Level :	4(normal) ▾
Color drop-out :	
Front side color drop-out :	None ▾
Back side color drop-out :	None ▾

! IMPORTANT

The [Double feed detection by Ultrasonic] setting only appears when using the ScanFront 300P.

Brightness (Front)

Adjusts the brightness of the image to be scanned.

Brightness (Back)

Enabled for duplex scanning. Use this option when the front and back sides of a document are shaded differently. To change the brightness settings for the front and back sides, clear the [Same as front] check box.

Contrast (Front)

Adjusts the contrast of the image to be scanned.

Contrast (Back)

Enabled for duplex scanning. Use this option when the front and back sides of a document are shaded differently. To change the contrast settings for the front and back sides, clear the [Same as front] check box.

Double feed detection by Ultrasonic (Only available with the ScanFront 300P)

The scanner uses an ultrasonic sensor to detect when two or more documents are fed together, and stops feeding when a double feed is detected.

! IMPORTANT

- This method is effective when documents overlap by 1.97" (50 mm) or more. It does not function if only a slight portion of the document is overlapping.
- When [Scanning Side] is set to [Folio], [Double feed detection by Ultrasonic] cannot be selected.

Double feed detection by length

The scanner detects by document length when two or more documents are fed together, and stops feeding when a double feed is detected.

! IMPORTANT

- Using the length of the first document page as a reference, the scanner detects a double feed when a subsequent page is longer or shorter than the reference page by 1.38" (35 mm) or more.
- Set [Double feed detection by length] to [OFF] when scanning a document that contains pages of different lengths.

Document orientation

Rotates the scanned image to the specified angle.



Hint

When [Auto] is selected, the scanner detects text orientation within the document and rotates the image so that the orientation of the text is correct.



IMPORTANT

The scanning speed may be reduced when [Auto] is selected.

Deskew

Detects when a document has been fed askew from the scanned image, and then straightens the image.

- **Prefer Quality**

Image processing is performed to minimize the loss of quality of an image that has deteriorated as result of deskewing.

- **Prefer Speed**

The image deteriorates slightly as a result of deskewing.



IMPORTANT

If you select [Prefer Quality], the scanning speed is reduced. If you are scanning a large number of pages, select [Prefer Speed] to prevent a decrease in scanning speed.

Bleed-through reduction

Eliminates bleed-through images, in which images on the reverse side of a scanned document appear on the scanned page, such as when scanning thin documents with text or images on both sides.



IMPORTANT

The bleed-through reduction setting is disabled when the scanning mode is set to [Text enhance].



Hint

When using bleed-through reduction, adjust the bleed-through reduction level to match the type of document.

Color drop-out

The color drop-out function has a “drop-out” effect that leaves out a specified color (red, blue, or green) while scanning, and a “color enhancement” effect that emphasizes a specified color.



IMPORTANT

The color drop-out setting is disabled when the scanning mode is set to [Color].



Hint

The OCR recognition rate is sometimes improved by deleting colored ruled lines and other objects with the color drop-out function.

Copying Job Buttons

You can copy the settings of a job button and register it as a new job button.

As an example, this section describes how to copy from the Shared Job Button to the My Job Button.



Hint

Use this function when you want to copy a job button between the Shared Job Button and My Job Button or register it as a different job button after changing some of the settings.

1. Select Shared Job Button for the [Job Button Type].
2. Select the job button you want to copy, and click [Copy].

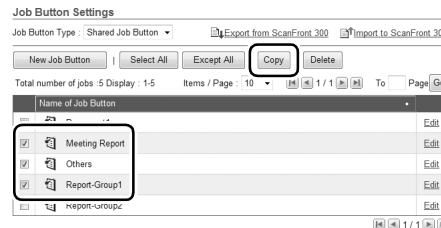

3. Select My Job Button for the copy destination, and click [OK].

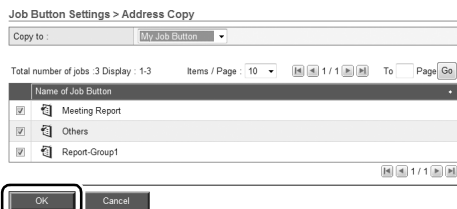

4. Confirm the copied job button.

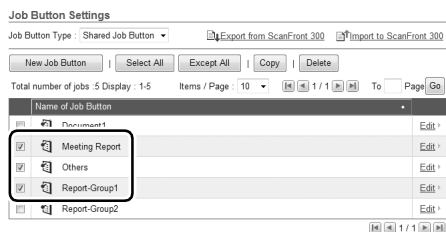

Editing Jobs

You can edit the settings of a registered job by clicking [Edit] in the job button list. The settings that can be edited are identical to those in “Registering New Job Buttons” on p. 4-17.

Exporting and Importing Job Buttons

You can back up your job button data as a settings file in DAT format, and import the backed up job button settings file to another ScanFront unit.

Hint

If you have multiple ScanFront units, you can use the same job buttons on all of them by importing the job button settings file registered on one ScanFront unit to the other units.

Exporting from the Scanner

You can save the job button settings file to a specified folder.

1. Click [Export from ScanFront 300].

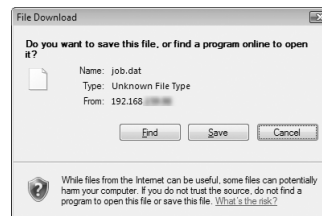

2. Click [Save], specify a save location, and save the job button settings file.

Importing to the Scanner

You can import a previously exported job button settings file to the scanner.

1. Click [Import to ScanFront 300].

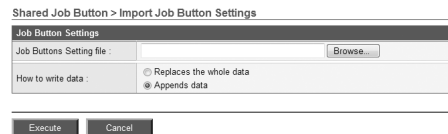

2. Specify a previously exported job button settings file.
3. Select a processing method for importing the job button settings file.
 - Replaces the whole data: Deletes all currently registered job buttons and overwrites them with the imported job buttons.
 - Appends data: Adds the imported job buttons to the currently registered job buttons.

4. Click [Execute].

Confirm the message that appears, and click [OK] to import the data.

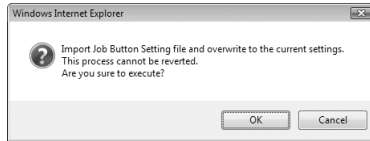

Hint

When importing is completed, the following message appears. Click [OK] to return to Job Button Settings and confirm the imported job button.



Chapter 5 Troubleshooting

1. Troubleshooting	5-2
--------------------------	-----

1. Troubleshooting

If any of the following problems occurs, solve the problem as described in the corresponding solution.

Network, Web Menu		
Cannot use an LDAP address book (certain users only)	Cause	The administrator has set user function restrictions.
	Solution	Contact the administrator of the ScanFront.
Cannot update the settings in the Web menu	Cause	The ScanFront is being used or a user has not logged out.
	Solution	Check the ScanFront status and then try again.
Cannot access the Web menu	Cause	The IP address assigned from the DHCP server has changed.
	Solution	Contact the administrator of the ScanFront, and check the IP address assigned to the ScanFront.
Cannot create a new folder (shared folder/FTP server)	Cause	Permission to write to the shared folder has not been granted for the user name and password that were entered.
	Solution	Contact the administrator of the shared folder.
Specifying a mail address as the address and then starting scanning results in an error	Cause	The mail server settings have not been registered, or have been deleted.
	Solution	Contact the administrator of the ScanFront.
Cannot edit the address book/job buttons (certain users only)	Cause	The administrator has set user function restrictions.
	Solution	Contact the administrator of the ScanFront.
Can only select certain destinations. For example, can only select shared folders (certain users only)	Cause	The administrator has set user function restrictions.
	Solution	Contact the administrator of the ScanFront.
Cannot connect to an FTP server that can be accessed from outside the company	Cause	The scanner cannot connect to an FTP server that requires firewall settings to be configured.
	Solution	Use an FTP server that does not require firewall settings to be configured.
The wrong send time is displayed for an e-mail message received at the destination	Cause	(1) The date and time settings are incorrect. (2) The time zone is set to a different country.
	Solution	Contact the administrator, and check the "Language/Timezone" setting.
The sender's address is not displayed at the destination of an e-mail message	Cause	The e-mail addresses of the user and administrator have not been registered.
	Solution	Contact the administrator, and register the e-mail addresses.

Cannot connect to the network (IP address conflict problem)	Cause	The IP address that was set is already being used by another device.
	Solution	Contact the system administrator of the network, and change the IP address setting.
Cannot connect to the network (LAN cable connection problem)	Cause	The LAN cable is not connected properly.
	Solution	Check the connections of the LAN cable.
Cannot connect to the network (device name conflict problem)	Cause	The device name that was set is already being used by another device.
	Solution	Contact the system administrator of the network, and change the device name setting. When you install two or more ScanFront scanners, take care to ensure duplicate device names are not set.
Cannot delete a folder	Cause	Data has been saved to the folder.
	Solution	Contact the administrator of the shared folder.
	Cause	Permission to change the shared folder has not been granted for the user name and password that were entered.
	Solution	Contact the administrator of the shared folder.
Cannot scan from the Home screen (certain users only)	Cause	The administrator has set user function restrictions.
	Solution	Contact the administrator of the ScanFront.
Cannot log in	Cause	Uppercase and lowercase letters were not entered correctly. (See p. 4-3 and p. 3-5.)
	Solution	Enter the uppercase and lowercase letters for the user name and password correctly.
Cannot browse shared folders during address registration.	Cause	You are attempting to browse folders on a computer running Windows 7 or Windows Server 2008 R2.
	Solution	Enter the full path of the shared folder manually. Alternatively, enter the computer name and path up until the top-most folder of that computer. (You can then press the [Browse] button and specify the rest of the path in the screen that appears.)
Cannot send image files to devices and folders on different segments of the network.	Cause	A ScanFront Service Server does not exist on the network. (A ScanFront Service Server has not been configured or is not running.)
	Solution	Install ScanFront Service on a computer on the same network as the scanner. If a ScanFront Service Server has been implemented, check the necessary settings. In addition, you must start the ScanFront Service Server before turning ON the ScanFront.

Scan		
Streaks appear in images	Cause	The scanning glass is dirty.
	Solution	Refer to the <i>ScanFront 300/300P INSTRUCTIONS</i> (electronic manual) and clean the scanning glass. If there are scratches on a scanning glass, contact your local authorized Canon dealer.
Paper becomes jammed	Cause	The rollers are dirty.
	Solution	Refer to the <i>ScanFront 300/300P INSTRUCTIONS</i> (electronic manual) and clean the rollers.
Paper jams occur frequently	Cause	The rollers (consumable parts) have worn out.
	Solution	Contact the administrator of the ScanFront and then replace the rollers.
Documents are double fed	Cause	Static electricity is causing the pages of the document to stick to each other.
	Solution	Before you load a stack of documents, fan the documents.
	Cause	The type of paper of the documents is causing a paper feed error.
	Solution	Load no more than ten pages of documents. (See p. 2-10.) Use bypass feeding to scan the pages one by one.
A stack of documents are fed together	Cause	The feed selection lever is set to Page Separation OFF. (See p. 2-5.)
	Solution	Set the feed selection lever to page separation feeding.
Scanning starts immediately after I press a job button (certain users only)	Cause	The job buttons are designed to work that way. See “Skip Scan Setting Screen” on p. 4-17.
	Solution	Place the document and then press a job button.

Hardware		
Cannot turn on the power	Cause	The AC adapter is not connected properly or the power plug is not inserted.
	Solution	Check the connections of the AC adapter and power plug. If the problem is not resolved after checking the connections, contact your local authorized Canon dealer.
The scanner does not turn ON when the power switch is pressed.	Cause	A USB memory device is inserted in the scanner.
	Solution	Remove the USB memory device, and restart the scanner.

Chapter 6 Index

1. Index	6-2
----------------	-----

1. Index

A

AC Adapter	1-7
Address	
Copying	3-25, 4-13
Modifying	3-25
New	3-22, 4-10
Address Book Settings	4-8
Address Selection Screen	3-15
Address Type	
E-mail	3-22, 4-10
Fax	4-12
FTP Server	3-23, 4-10
Group	3-24, 4-12
Shared Folder	3-22, 4-11

C

Card	2-3
Conceptual Diagram of the ScanFront	i
Copying Job Buttons	4-22
Custom File Name Settings	4-6

D

Delivery Options	3-34
Detailed Settings	3-29, 4-21
Device Authentication	3-4, 4-3
Disposal	1-5
Documents	2-2
Double Feed Error	2-9

E

Eject Tray	2-4
Exporting and Importing Address Books	4-13
Exporting and Importing Job Buttons	4-23

F

Feed Selection Lever	2-5
Feed Tray	2-4
File Formats	3-32, 4-20
Fingerprint Authentication	2-12, 3-7
Fingerprint Registration	3-10
Fingerprint Sensor	1-6, 2-11
Flow Up Until Sending an Image File	3-2

H

Handling	1-3
Home Screen	3-8

I

Index Settings	4-6, 4-18
Installation Location	1-2
Introduction	i

J

Job Button Screen	3-8
Job Button Settings	4-15, 4-17
Address Settings	4-17
Delivery Options	4-17
Detailed Settings	4-17
E-mail Settings	4-17
Scan Settings	4-17

K

Key in Type Login	3-6
-------------------------	-----

L

List Type Login	3-5
Loading Mark	2-7
Lock Lever	2-10
Logging In to the Web Menu	4-3
Login Screen	
Key in Type	3-4
List Type	3-4
Server Authentication	3-4

M	
Moving the Scanner	1-3
N	
Names and Functions of Parts	1-6
P	
Paper Jam	2-9
Placing a Card	2-8
Placing a Folded Document	2-7
Placing a Long Document	2-7
Placing Documents	2-6
Plain Paper	2-2
Preparing the Scanner	2-4
R	
Registering New Job Buttons	4-17
S	
Safety Instructions	1-2
Scan Settings	3-28, 4-18
Basic Condition Settings	3-28
Detailed Settings	3-29
Scan/Delivery Options	3-27
Scanning	3-18
Security Settings	3-33
Server Authentication	3-4, 4-3
T	
Troubleshooting	5-2
Turning Off the Power	3-3
Turning On the Power	3-3
U	
USB Memory	3-16
USB Memory Screen	3-16
USB Port	2-5
User Settings	4-4
User Settings Screen	3-9
Change Password	3-9
Fingerprint Registration	3-9

W	
Web Menu	
User Mode	4-2
Web Menu Overview	4-2



CANON ELECTRONICS INC.

1248, SHIMOKAGEMORI, CHICHIBU-SHI, SAITAMA 369-1892, JAPAN

CANON U.S.A. INC.

ONE CANON PLAZA, LAKE SUCCESS, N.Y. 11042, U.S.A.

CANON CANADA INC.

6390 DIXIE ROAD, MISSISSAUGA, ONTARIO L5T 1P7, CANADA

CANON EUROPA N.V.

BOVENKERKERWEG 59-61, P.O.BOX 2262, 1180 EG AMSTELVEEN, THE NETHERLANDS

CANON LATIN AMERICA, INC.

703 WATERFORD WAY, SUITE 400 MIAMI, FLORIDA 33126, U.S.A.

CANON AUSTRALIA PTY. LTD.

1 THOMAS HOLT DRIVE, NORTH RYDE, SYDNEY. N.S.W, 2113. AUSTRALIA

CANON SINGAPORE PTE. LTD.

1 HARBOUR FRONT AVENUE #04-01, KEPPEL BAY TOWER, SINGAPORE 098632

CANON HONGKONG COMPANY LTD.

19TH FLOOR, THE METROPOLIS TOWER, 10 METROPOLIS DRIVE, HUNGHOM, KOWLOON, HONG KONG.

CANON KOREA BUSINESS SOLUTIONS INC.

168-12 SAMSEONG-DONG, GANGNAM-GU, SEOUL, KOREA